

Basic Operation Guide

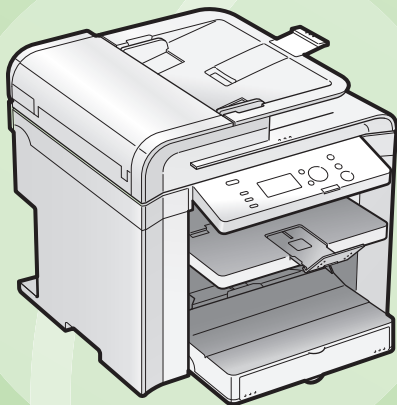

Quick View- Perform Useful Tasks  [Next Page](#)

1

[Before Using the Machine](#)  [P.1-1](#)

2

[Document and Paper Handling](#)  [P.2-1](#)

3

[Copying](#)  [P.3-1](#)

4

[Printing from a Computer](#)  [P.4-1](#)

5

[Using the Scan Functions](#)  [P.5-1](#)

6

[Maintenance](#)  [P.6-1](#)

7

[Troubleshooting](#)  [P.7-1](#)



8

[Registering/
Setting the Various Functions](#)  [P.8-1](#)

9

[Appendix](#)  [P.9-1](#)

- Security Functions
- Searching in Detail

 See the e-Manual.
 User Software CD-ROM

- Searching the Installation and Connection Procedure

 See the Starter Guide.

 Be sure to read the manual before using the machine.
Keep the manual for future reference.

Copy

Print

Scan

There are a variety of print functions that are explained in later pages of this manual as well as in the e-Manual. Enlarge or reduce documents and print multiple-page data onto one sheet. You can also perform 2-sided printing.

Below is a quick overview of highlighted print features that you can utilize in your everyday use.

● Various Printing Functions ● ● ● ● For details, see "Printing from a Computer" from p. 4-1.

● Enlarged/Reduced Printing

You can enlarge or reduce standard size documents to copy on standard size paper or specify the copy ratio in percentage.

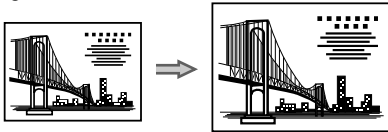

● 2-Sided Printing

You can print on both sides of paper.

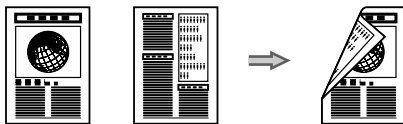

● Reduced Layout

You can reduce multiple documents to print them onto one sheet.

2 on 1

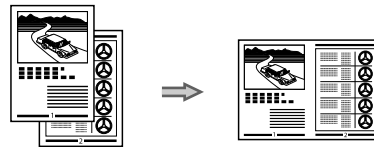

4 on 1

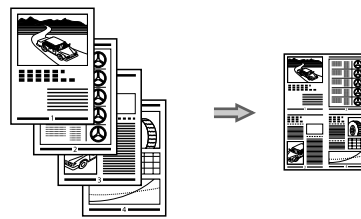

● Miscellaneous Printing Functions ● ● ● For details, see "Print" in the e-Manual.

● Booklet Printing

Booklet printing allows you to make a booklet by folding printouts in half.

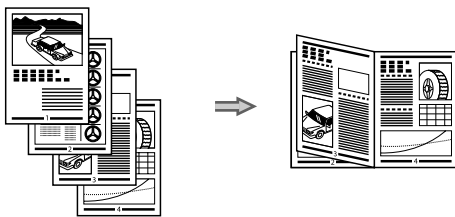

● Poster Printing

You can magnify and divide a single page image to print it out on multiple sheets of paper. You can make one large poster by joining these printouts together.

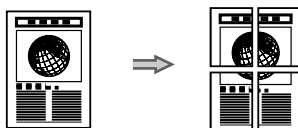

● Watermark Printing

You can superimpose watermarks (such as [COPY] and [DRAFT]) over the documents created by an application.

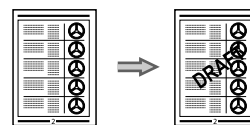

● Displaying a Preview before Printing

You can check the printout result on a computer display.

● Selecting a "Profile"

Some printer driver settings are provided as "Profiles" beforehand.

You can perform printing which suits your needs only by selecting a "Profile."

Quick View- Perform Useful Tasks

Copy

Print

Scan

There are a variety of scan functions that are explained in later pages of this manual as well as in the e-Manual. You can easily send scanned documents to your computer.

Below is a quick overview of highlighted scan features that you can utilize in your everyday use.

● Saving in a Computer

There are two methods for saving scanned documents in a computer.

● Saving the Documents Using the Operation Panel of the Machine

For details, see "Using the Scan Functions" from p. 7-1.

You can easily save scanned documents in a computer only by operating the operation panel of the machine. Various scanning settings have been prepared for your purposes. Therefore, you can create a "Searchable PDF*" file, which can be used for text retrieval or as text data, without specifying special settings.

* If you are using Macintosh, you may not create "Searchable PDF."

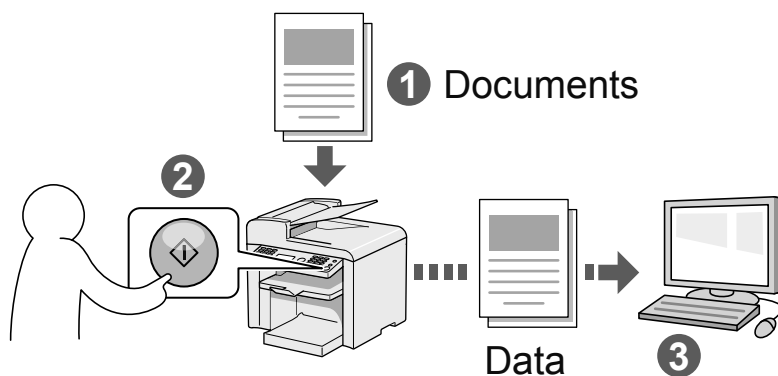

● Saving the Documents Using Operations from a Computer

For details, see "Scan" in the  e-Manual.

● Scanning with the MF Toolbox*

Scanning is performed by operating the software supplied with the machine.

* MF Toolbox for Macintosh and MF Toolbox for Windows may be different in some features. For details, see the Scanner Driver Guide.

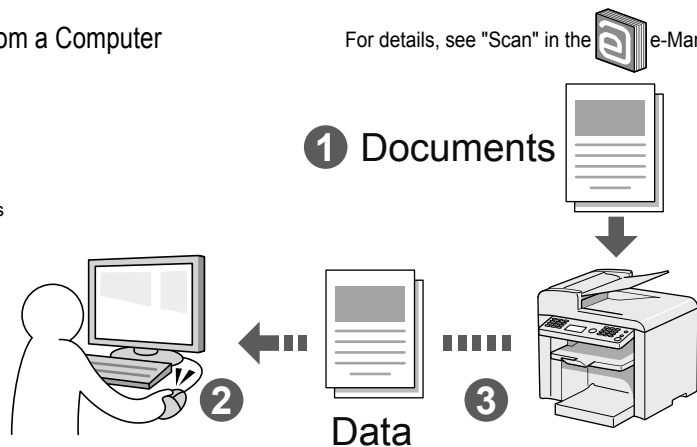

● Scanning from an Application

Scanning is performed using your application. This allows you to open the scanned data as is in your application.

● Scanning with the WIA Driver (Windows XP/Vista/7 Only)

Scanning is performed using the driver system supplied with Windows operating systems.

There are various scanning methods.

- Scanning from the [Scanner and Camera Wizard] dialog box
- Scanning from the [Windows Fax and Scan] dialog box
- Scanning from Windows Photo Gallery
- Scanning from an Application

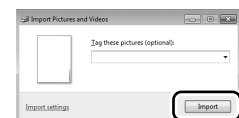

Contents

Contents	ii
Manuals for the Machine	iv
Available Features	v
How to Use This Manual	v
Important Safety Instructions	vi
Installation Requirements and Handling	x
Legal Notices	xii
Laser Safety	xiv

1. Before Using the Machine 1-1

Names and Functions on Each Part of the Machine	1-2
Front Side	1-2
Back Side	1-3
Interior	1-3
Multi-purpose Tray	1-4
Paper Cassette	1-4
Operation Panel	1-5
LCD (Standby Mode)	1-6
Copy Mode	1-6
Scan Mode	1-6
Navigating the Menu	1-7
Entering the Menu Screen	1-7
Scrolling Through Menu Items	1-7
Selecting a Menu Item	1-7
Specifying values using the navigation keys	1-8
Returning to the Default Screen	1-8
Text Input Method	1-9
Entering text, symbols, and numbers	1-9
Deleting text, symbols, and numbers	1-9
Setting the Sleep Timer	1-10
Setting the Current Date and Time	1-11

2. Document and Paper Handling 2-1

Document Requirements	2-2
Scanning Range	2-3
Copy	2-3
Scan	2-3
Placing Documents	2-4
Placing Documents on the Platen Glass	2-4
Loading Document in the Feeder	2-4
Paper Requirements	2-6
Paper Size	2-6
Paper Type	2-7

Printable Range	2-8
Loading Paper	2-9
In the Paper Cassette	2-9
In the Multi-Purpose Tray	2-11
Precautions when Loading Paper	2-12
Paper Loading Capacity	2-12
Paper Loading Orientation	2-13
When printing paper with a letterhead or logo (Previously printed paper)	2-13
Printing on Envelopes	2-13
Setting a Paper Size and Type	2-14
Setting a Custom Paper Size	2-14
Selecting Print Side	2-16
When setting this item to <Print Speed Priority> (the default setting)	2-16
When setting this item to <Print Side Priority>	2-16

3. Copying 3-1

Basic Copying Method	3-2
Checking and Canceling Copy Jobs	3-3
Canceling using the Stop Key	3-3
Checking and Canceling using the Status Monitor/Cancel Key	3-3
Copy Settings	3-4
Adjusting the Density	3-4
Selecting Image Quality (Copy)	3-4
2-Sided Copying	3-5
Enlarging/Reducing Copies	3-6
Multiple Documents onto One Sheet (N on 1)	3-6
Collating Copies	3-7
Emphasize the Outline of an Image (Sharpness)	3-7
Copying an ID Card	3-8
Changing the Default Values	3-9

4. Printing from a Computer 4-1

Installing the Printer Driver	4-2
Printing from a Computer	4-3
Scaling Documents	4-3
Printing Multiple Pages on One Sheet	4-3
2-sided Printing	4-4
Checking and Canceling Print Jobs	4-5

5. Using the Scan Functions 5-1

Basic Operation Methods for Scanning	5-2
--------------------------------------	-----

6. Maintenance 6-1

Cleaning the Machine	6-2
----------------------	-----

Cleaning the Exterior	6-2
Cleaning the Interior	6-2
Cleaning the Fixing Unit	6-3
Cleaning the Platen Glass	6-4
Cleaning the Feeder	6-4
Precautions When Cleaning the Machine	6-4

Replacing Toner Cartridges	6-6
----------------------------	-----

About the Supplied Toner Cartridge	6-6
About Replacement Toner Cartridge	6-6
Handling Toner Cartridge	6-6
Using the Toner Saver Mode	6-7
Before Replacing the Toner Cartridge	6-8
Replacing the Toner Cartridge	6-9
Precautions when Replacing Toner Cartridge	6-11
Purchase Consumables	6-12

Recycling Used Cartridges	6-13
---------------------------	------

The Clean Earth Campaign	6-13
U.S.A. PROGRAM	6-13
Packaging	6-13
Shipping	6-14
CANADA PROGRAM-CANADA PROGRAMME	6-15

Transporting the Machine	6-16
--------------------------	------

Precautions when Transporting the Machine	6-17
---	------

7. Troubleshooting 7-1

Clearing Jams	7-2
---------------	-----

Document Jams in the Feeder	7-3
Paper Jams Inside the Machine	7-4

Display Message	7-7
-----------------	-----

Error Codes	7-7
-------------	-----

If <Incorrect Size/Setting> Appears	7-8
-------------------------------------	-----

Troubleshooting	7-9
-----------------	-----

Check the Following First	7-9
Is the power switched ON?	7-9
Has the power switch been just turned ON?	7-9
Is the machine in Sleep mode?	7-9
Are the settings proper?	7-9
Is the Error indicator on or blinking?	7-9
Does a message appear on the display?	7-10
If You Cannot Solve a Problem	7-10

If a Power Failure Occurs	7-11
---------------------------	------

If You Cannot Solve a Problem	7-12
-------------------------------	------

Customer Support (U.S.A.)	7-12
Customer Support (Canada)	7-12

Print Result Is Not Good	7-13
--------------------------	------

Paper Curls	7-13
Paper Creases	7-13
Printing Is Uneven	7-14
White Specks Appear	7-15
The Toner Does Not Fix onto the Paper Well	7-15
The Printed Paper Has Vertical Streaks	7-16
Smudge Marks of Spattering Toner Appear around the Text or Patterns	7-17
The Overall Print Result Is Dark	7-17
Copied Lines and Text Appear Faded	7-18
Printed Bar Codes Cannot Be Scanned	7-18
Paper Jams Occur Frequently When Performing 2-Sided Printing	7-18

8. Registering/Setting the Various Functions 8-1

Setting Menu List	8-2
-------------------	-----

Printing a User Data List	8-2
Contents of the Setting Menu	8-2

9. Appendix 9-1

Main Specifications	9-2
---------------------	-----

Machine Specifications	9-2
Copy Specifications	9-2
Printer Specification	9-2
Scanner Specifications	9-3

For Macintosh Users	9-4
---------------------	-----

Displaying Driver Guides (PDF Files)	9-4
Displaying a Driver's Help System	9-4
Content of the e-Manual about Features that Are Unavailable on the Macintosh	9-4

Index	9-5
-------	-----

Manuals for the Machine

Read this manual first.

This manual describes the settings for setting up the machine and installing the software. Be sure to read this manual before using the machine.

Starter Guide



- Preface
- Installing the Machine
- Connecting to a Computer and Installing the Drivers
- Appendix

Read this manual next.

This manual describes the basic use of the machine.

Basic Operation Guide

This manual

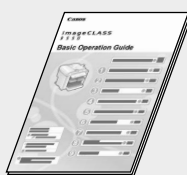

- Before Using the Machine
- Document and Paper Handling
- Copying
- Printing from a Computer
- Using the Scan Functions
- Maintenance
- Troubleshooting
- Registering/Setting Functions
- Appendix

Read the desired chapter to suit your needs.

The e-Manual is categorized by subject to find desired information easily.

e-Manual

* The e-Manual is included in the User Software CD-ROM.



- Basic Operation
- Copy
- Print *
- Scan *
- Security
- Setting and Managing from Computer
- Troubleshooting
- Maintenance
- Setting Menu List
- Specifications

* If you are using Macintosh, see the following Driver Guides or Help for more details on these functions.

You can find the driver guides in the following locations on the User Software CD-ROM.

- Print: User Software CD-ROM → [Manuals] → [GUIDE-UFR II-US.pdf]
- Scan: User Software CD-ROM → [Manuals] → [GUIDE-SCAN-US.pdf]

Available Features

The following features are available for each model.

○ : available

— : not available

	Copy	Print	2-sided Printing	Scan	ADF (2-sided)
D550	○	○	○	○	○

How to Use This Manual

Symbols Used in This Manual



WARNING

Indicates a warning concerning operations that may lead to death or injury to persons if not performed correctly. To use the machine safely, always pay attention to these warnings.



CAUTION

Indicates a caution concerning operations that may lead to injury to persons if not performed correctly. To use the machine safely, always pay attention to these cautions.



IMPORTANT

Indicates operational requirements and restrictions. Be sure to read these items carefully to operate the machine correctly, and avoid damage to the machine or property.



NOTE

Indicates a clarification of an operation, or contains additional explanations for a procedure. Reading these notes is highly recommended.



Indicates an operation that must not be performed. Read these items carefully, and make sure not to perform the described operations.

Keys and Buttons Used in This Manual

The following symbols and key names are a few examples of how keys to be pressed are expressed in this manual.

- Operation panel keys: [Key icon] + (Key name)
Example: [] (Stop)
- Display: <Start Copying>
- Buttons and items on the computer display: [Preferences]

Displays Used in This Manual

The display used in this manual is the factory preset display for this machine. Depending on the system configuration and product purchased, the appearance of the display may differ.

Important Safety Instructions

Please read these "Important Safety Instructions" thoroughly before operating the machine.

As these instructions are intended to prevent injury to the user and other persons or to prevent destruction of property, always pay attention to these instructions and operational requirements.

Also, as it may result in unexpected accidents or injuries, do not perform any operation unless otherwise specified in the manual.

Installation

WARNING

- Do not install the machine in a location near alcohol, paint thinner, or other flammable substances. If flammable substances come into contact with electrical parts inside the machine, this may result in a fire or electrical shock.
- Do not place the following items on the machine.
 - Necklaces and other metal objects
 - Cups, vases, flowerpots, and other containers filled with water or liquids

If these items come into contact with a high-voltage area inside the machine, this may result in a fire or electrical shock. If these items are dropped or spilled inside the machine, immediately turn off the power switches of the machine and computer (1) and disconnect the interface cable if it is connected (2). Then, unplug the power plug from the AC power outlet (3) and contact your local authorized Canon dealer.

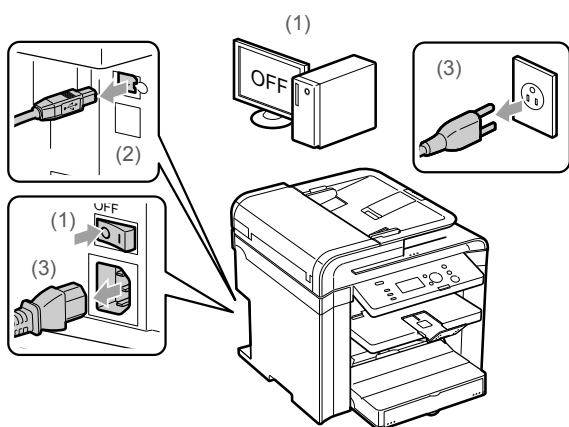

CAUTION

- Do not install the machine in unstable locations, such as on unsteady platforms or inclined floors, or in locations subject to excessive vibrations, as this may cause the machine to fall or tip over, resulting in personal injury.
- The ventilation slots are provided for proper ventilation of working parts inside the machine. Never place the machine on a soft surface, such as a bed, sofa, or rug. Blocking the slots can cause the machine to overheat, resulting in a fire.

- Do not install the machine in the following locations, as this may result in a fire or electrical shock.
 - A damp or dusty location
 - A location exposed to smoke and steam, such as near a cookery or humidifier
 - A location exposed to rain or snow
 - A location near a water faucet or water
 - A location exposed to direct sunlight
 - A location subject to high temperatures
 - A location near open flames
- When installing the machine, gently lower the machine to the installation site so as not to catch your hands between the machine and the floor or between the machine and other equipment, as this may result in personal injury.
- When connecting the interface cable, connect it properly by following the instructions in this manual. If not connected properly, this may result in malfunction or electrical shock.
- When moving the machine, follow the instructions in this manual to hold it correctly. Failure to do so may cause you to drop the machine, resulting in personal injury.
 - ☒ "Transporting the Machine" (→P.6-16)

Power Supply

WARNING

- Do not damage or modify the power cord. Also, do not place heavy objects on the power cord or pull on or excessively bend it. This can cause electrical damage, resulting in fire or electrical shock.
- Keep the power cord away from all heat sources. Failure to do so can cause the power cord insulation to melt, resulting in a fire or electrical shock.
- The power cord should not be taut, as this may lead to a loose connection and cause overheating, which could result in a fire.
- The power cord may become damaged if it is stepped on, fixed with staples, or if heavy objects are placed on it. Continued use of a damaged power cord can lead to an accident, such as a fire or electrical shock.
- Do not plug or unplug the power plug with wet hands, as this can result in electrical shock.
- Do not plug the power cord into a multiplug power strip, as this can result in a fire or electrical shock.
- Do not bundle up or tie up the power cord in a knot, as this can result in a fire or electrical shock.
- Insert the power plug completely into the AC power outlet. Failure to do so can result in a fire or electrical shock.
- If excessive stress is applied to the connection part of the power cord, it may damage the power cord or the wires inside the machine may disconnect. This could result in a fire. Avoid the following situations:
 - Connecting and disconnecting the power cord frequently.
 - Tripping over the power cord.

- The power cord is bent near the connection part, and continuous stress is being applied to the power outlet or the connection part.
- Applying a shock to the power connector.
- Do not use power cords other than the one provided, as this can result in a fire or electrical shock.
- As a general rule, do not use extension cords. Using an extension cord may result in a fire or electrical shock.
- Remove the power plug from the AC power outlet and refrain from using the machine during a thunder storm. Lightening can result in a fire, electrical shock or malfunction.

! CAUTION

- Do not use a power supply voltage other than that listed herein, as this may result in a fire or electrical shock.
- Always grasp the power plug when unplugging the power plug. Do not pull on the power cord, as this may expose the core wire of the power cord or damage the cord insulation, causing electricity to leak, resulting in a fire or electrical shock.
- Leave sufficient space around the power plug so that it can be unplugged easily. If objects are placed around the power plug, you may be unable to unplug it in an emergency.

Handling

! WARNING

- Do not disassemble or modify the machine. There are high-temperature and high-voltage components inside the machine which may result in a fire or electrical shock.
- Electrical equipment can be hazardous if not used properly. Do not allow children to touch the power cord, cables, internal gears, or electrical parts.
- If the machine makes an unusual noise or emits smoke, heat, or an unusual smell, immediately turn off the power switches of the machine and computer and disconnect the interface cable if it is connected. Then, unplug the power plug from the AC power outlet and contact your local authorized Canon dealer. Continued use can result in a fire or electrical shock.
- Do not use flammable sprays near the machine. If flammable substances come into contact with electrical parts inside the machine, this may result in a fire or electrical shock.
- Always turn off the power switches of the machine and computer, and then unplug the power plug and interface cables before moving the machine. Failure to do so can damage the cables or cords, resulting in a fire or electrical shock.
- Confirm that the power plug or power connector is inserted completely after moving the machine. Failure to do so can result in an overheating and fire.
- Do not drop paper clips, staples, or other metal objects inside the machine. Also, do not spill water, liquids, or other flammable substances (alcohol, benzene, paint thinner, etc.) inside the machine. If these items come into contact with a high-voltage area inside the machine, this may result in a fire or electrical shock. If these items are dropped or spilled inside the machine, immediately turn off the power switches of the machine and computer and disconnect the interface cable if it is connected. Then, unplug the power plug from the AC power outlet and contact your local authorized Canon dealer.
- When plugging or unplugging a USB cable when the power plug is plugged into an AC power outlet, do not touch the metal part of the connector, as this can result in electrical shock.

! CAUTION

- Do not place heavy objects on the machine. The object or the machine may fall, resulting in personal injury.
- Turn off the power switch when the machine will not be used for a long period of time, such as overnight. Turn off the machine and unplug the power plug if the machine will not be used for an extended period of time, such as for several days.
- Open or close covers and install or remove cassettes gently and carefully. Be careful not to hurt your fingers.
- Keep your hands and clothing away from the roller in the output area. Even if the machine is not printing, the roller may suddenly rotate and catch your hands or clothing, resulting in personal injury.
- The output slot is hot during and immediately after printing. Do not touch the area surrounding the output slot, as this may result in burns.
- Printed paper may be hot immediately after being output. Be careful when removing the paper and aligning the removed paper, especially after continuous printing. Failure to do so may result in burns.
- When performing copy with a thick book placed on the platen glass, do not press the feeder forcefully. This may damage the platen glass and cause personal injury.
- Be careful not to drop a heavy object, such as a dictionary, on the platen glass. This may damage the platen glass and cause personal injury.
- Close the feeder gently so as not to catch your hand. This may result in personal injury.
- The laser beam can be harmful to the human body. The laser beam is confined in the laser scanner unit by a cover, so there is no danger of the laser beam escaping during normal machine operation. Read the following remarks and instructions for safety.
 - Never open covers other than those indicated in this manual.
 - Do not remove the caution label attached to the cover of the laser scanner unit.

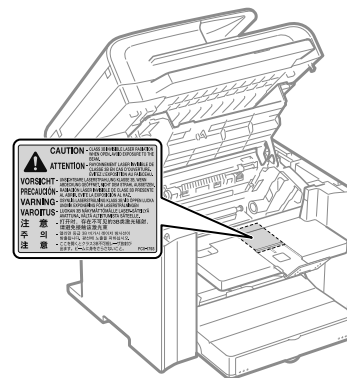

- If the laser beam should escape and enter your eyes, exposure may cause damage to your eyes.
- If you operate this machine in manners other than the control, adjustment, and operating procedures prescribed in this manual, this may result in hazardous radiation exposure.
- This machine is confirmed as the class 1 laser product in IEC60825-1:2007.

Maintenance and Inspections

WARNING

- When cleaning the machine, turn off the machine and computer, and unplug the interface cables and power plug. Failure to do so can result in a fire or electrical shock.
- Unplug the power plug from the AC power outlet periodically and clean the area around the base of the power plug's metal pins and the AC power outlet with a dry cloth to remove all dust and grime. In damp, dusty, or smoky locations, dust can build up around the power plug and become damp, which can cause a short circuit, resulting in a fire.
- Clean the machine with a well wrung out cloth dampened with water or mild detergent diluted with water. Do not use alcohol, benzene, paint thinner, or other flammable substances. If flammable substances come into contact with electrical parts inside the machine, this may result in a fire or electrical shock.
- Some areas inside the machine are subject to high voltage. When removing jammed paper or when inspecting inside of the machine, be careful not to allow necklaces, bracelets, or other metal objects to touch the inside of the machine, as this can result in burns or electrical shock.
- Do not dispose of used toner cartridges in open flames. This may cause the toner remaining inside the cartridges to ignite, resulting in burns or fire.
- Confirm that the power plug or power connector is inserted completely after cleaning the machine. Failure to do so can result in an overheating and fire.
- Check the power cord and plug regularly. The following conditions may result in fire, so please contact your local authorized Canon dealer or the Canon help line.
 - There are burn marks on the power plug.
 - The blade on the power plug is deformed or broken.
 - The power is turned OFF or ON when bending the power cord.
 - The coating of the power cord is damaged, cracked, or dented.
 - A part of the power cord becomes hot.
- Check regularly that the power cord and plug are not handled in the following manner. Failure to do so can result in a fire or electrical shock.
 - The power connector is loosened.
 - Stress is being applied to the power cord by a heavy object or by fixing it with staples.
 - The power plug is loosened.
 - The power cord is tied in a bundle.
 - A part of the power cord is put in an aisle.
 - The power cord is put in front of the heating appliance.

CAUTION

- The fixing unit and its surroundings inside the machine become hot during use. When removing jammed paper or when inspecting the inside of the machine, do not touch the fixing unit and its surroundings, as this may result in burns.

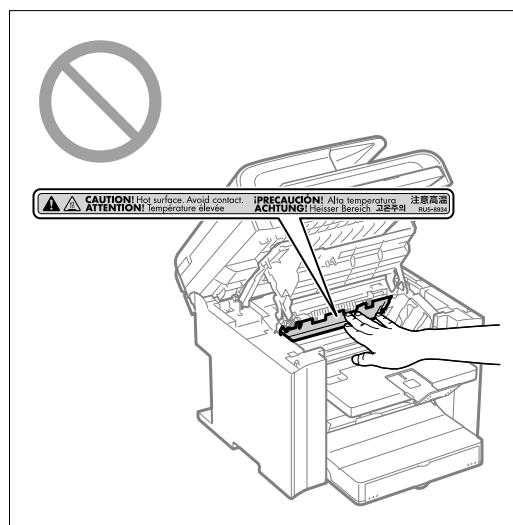

- When removing jammed paper or when inspecting the inside of the machine, do not expose yourself to the heat emitted from the fixing unit and its surroundings for a prolonged period of time. Doing so may result in low temperature burns, even though you did not touch the fixing unit and its surroundings directly, as this may result in burns.
- If paper is jammed, remove the jammed paper so that any pieces of paper do not remain inside the machine according to the displayed message. Also, do not put your hand in an area other than indicated areas, as this may result in personal injuries or burns.
- When removing jammed paper or replacing a toner cartridge, be careful not to get any toner on your hands or clothing, as this will dirty your hands or clothing. If toner gets on your hands or clothing, wash them immediately with cold water. Washing with warm water sets the toner, making it impossible to remove the toner stains.
- When removing jammed paper, be careful not to allow the toner on the paper to scatter. The toner may get into your eyes or mouth. If toner gets into your eyes or mouth, wash them immediately with cold water and consult a physician.
- When loading paper or removing jammed documents or paper, be careful not to cut your hands with the edges of the paper.
- When removing a toner cartridge, remove the toner cartridge carefully so as to prevent the toner from scattering and getting into your eyes or mouth. If toner gets into your eyes or mouth, wash them immediately with cold water and consult a physician.
- Do not attempt to disassemble the toner cartridge. The toner may scatter and get into your eyes or mouth. If toner gets into your eyes or mouth, wash them immediately with cold water and consult a physician.
- If toner leaks from the toner cartridge, be careful not to inhale the toner or allow it to come into direct contact with your skin. If the toner comes into contact with your skin, wash with soap. If the skin becomes irritated or you inhale the toner, consult a physician immediately.

Consumables

WARNING

- Do not dispose of used toner cartridges in open flames. This may cause the toner to ignite, resulting in burns or fire.
- Do not store toner cartridges or paper in a location exposed to open flames. This may cause the toner or paper to ignite, resulting in burns or fire.
- When disposing of a toner cartridge, place the toner cartridge into a bag to prevent the toner from scattering, and then dispose of the toner cartridge according to local regulations.

CAUTION

- Keep the toner cartridges and other consumables out of the reach of small children. If the toner or other parts are ingested, consult a physician immediately.
- Do not attempt to disassemble the toner cartridge. The toner may scatter and get into your eyes or mouth. If toner gets into your eyes or mouth, wash them immediately with cold water and consult a physician.
- If toner leaks from the toner cartridge, be careful not to inhale the toner or allow it to come into direct contact with your skin. If the toner comes into contact with your skin, wash with soap. If the skin becomes irritated or you inhale the toner, consult a physician immediately.
- Do not pull out the sealing tape forcefully or stop at midpoint, as this may cause toner to spill out. If toner gets into your eyes or mouth, wash them immediately with cold water and consult a physician.

Others

WARNING

- If you are using a cardiac pacemaker
This machine generates a low level magnetic field. If you use a cardiac pacemaker and feel abnormalities, please move away from this machine and consult your physician immediately.

Installation Requirements and Handling

In order to use this machine in a safe and trouble-free manner, install the machine in a place that fulfills the following conditions. Also, read the remarks carefully.

Temperature and Humidity Conditions

- Temperature range: 50 to 86°F (10 to 30°C)
- Humidity range: 20 to 80 % RH (no condensation)

IMPORTANT

Protecting the machine from condensation

- To prevent condensation from forming inside the machine in the following cases, let the machine adjust to the ambient temperature and humidity for at least two hours before use.
 - When the room where the machine is installed is heated rapidly
 - When the machine is moved from a cool or dry location to a hot or humid location
- If water droplets (condensation) form inside the machine, this can result in paper jams or poor print quality.

When using an ultrasonic humidifier

When you are using an ultrasonic humidifier, it is therefore recommended that you use purified water or other water that is free of impurities.

If you use tap water or well water, impurities in the water will be dispersed through the air. This can be trapped inside the machine, causing degradation in print quality.

Power Supply Requirements

120 to 127 V, 60 Hz

IMPORTANT

Precautions when connecting the power cord

- Do not connect this machine to an uninterruptible power source.
- Use an AC power outlet exclusively for the machine. Do not use the other sockets of the AC power outlet.
- Do not plug the power plug into the auxiliary outlet on a computer.
Do not use the same AC power outlet for both the machine and any of the following equipment.
 - Copy machine
 - Air conditioner
 - Shredder
 - Equipment that consumes a large amount of electricity
 - Equipment that generates electrical noise
- When unplugging the power cord, keep interval of 5 seconds or more before plugging it again.

Miscellaneous precautions

- The maximum power consumption of the machine is 1,090 W or less.
- Electrical noise or a dramatic drop in supplied voltage may cause the machine or computer to operate incorrectly or lose data.

Installation Requirements

- A location with sufficient space
- A location with good ventilation
- A location with a flat, even surface
- A location able to fully support the weight of the machine

IMPORTANT

Do not install the machine in the following locations, as this may result in damage to the machine.

- A location subject to dramatic changes in temperature or humidity
- A location subject to condensation
- A poorly ventilated location
(If you use the machine for a long time or to perform a large amount of printing in a poorly ventilated room, the ozone or other odors generated by the machine may create an uncomfortable working environment. In addition, chemical particles are dispersed during printing; therefore, it is important to provide adequate ventilation.)
- A location near equipment that generates magnetic or electromagnetic waves
- A laboratory or location where chemical reactions occur
- A location exposed to salt air, corrosive gases, or toxic gases
- A location, such as on a carpet or mat, that may warp from the weight of the machine or where the machine is liable to sink.

Installation Space

Required installation space

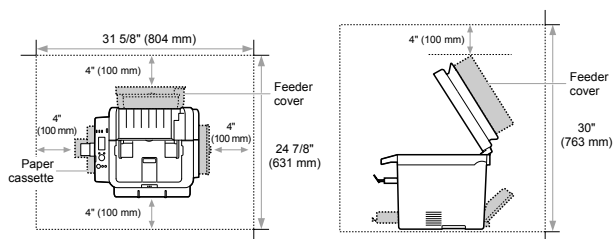

Maintenance and Inspections



IMPORTANT

- Follow the instructions in the caution label attached to this machine.
- Avoid shaking or applying a shock to this machine.
- To prevent a paper jam, do not turn the power ON/OFF, open/close the operation panel or rear cover, and load/unload paper in the middle of printing operation.
- Be sure to remove the toner cartridge from the machine when transporting the machine to a distance.
- To avoid exposing the toner cartridge to light, place it in the protective bag included with this machine or wrap it in a thick cloth.
- Clean this machine regularly. If this machine becomes dusty, it may operate improperly.
- The repairing parts and toner cartridges for the machine will be available for at least seven (7) years after production of this machine model has been discontinued.

Customer Support

Customer Support (U.S.A.)

Your machine is designed with the latest technology to provide trouble-free operation. If you encounter a problem with the machine's operation, try to solve it by using the information in Chapter 9. If you cannot solve the problem or if you think your machine needs servicing, contact Canon Customer Care Center at 1-800-OK-CANON between the hours of 8:00 A.M. to 8:00 P.M. EST Monday through Friday. On-line support for 24 hours is also available at the website. <http://www.canontechsupport.com/>

Customer Support (Canada)

Canon Canada Inc., offers a full range of customer technical support options*:

- For step-by-step troubleshooting, e-mail technical support, the latest driver or document downloads, and answers to frequently asked questions, visit <http://www.canon.ca/>
- Free live technical support 9 A.M. to 8 P.M. EST Monday through Friday (excluding holidays) for products still under warranty 1-800-OK-CANON
- For the location of the authorized service facility nearest you, visit <http://www.canon.ca/> or 1-800-OK-CANON
- If the problem cannot be corrected by using one of the above technical support options, repair options are available at the time of your call to the live technical support number above or via the website at <http://www.canon.ca/>

* Support program specifics are subject to change without notice.

Legal Notices

International ENERGY STAR Program



As an ENERGY STAR® Partner, Canon U.S.A., Inc. has determined that this product meets the ENERGY STAR Program for energy efficiency.

The International ENERGY STAR Office Equipment Program is an international program that promotes energy saving through the use of computers and other office equipment.

The program backs the development and dissemination of products with functions that effectively reduce energy consumption. It is an open system in which business proprietors can participate voluntarily.

The targeted products are office equipment, such as computers, displays, printers, facsimiles, and copiers. The standards and logos are uniform among participating nations.

IPv6 Ready Logo



The protocol stack included in this machine has obtained the IPv6 Ready Logo Phase-1 established by the IPv6 Forum.

Trademarks

Canon, the Canon logo, and imageCLASS are registered trademarks of Canon Inc. in the United States and may also be trademarks or registered trademarks in other countries.

Apple, Mac OS, and Macintosh are trademarks or registered trademarks of Apple Inc. in the U.S. and/or other countries.

Microsoft, Windows and Windows Vista are either trademarks or registered trademarks of Microsoft Corporation in the United States and/or other countries.

All other product and brand names are registered trademarks, trademarks or service marks of their respective owners.

Copyright

© 2011 by Canon Inc. All rights reserved.

No part of this publication may be reproduced, transmitted, transcribed, stored in a retrieval system, or translated into any language or computer language in any form or by any means, electronic, mechanical, magnetic, optical, chemical, manual, or otherwise, without the prior written permission of Canon Inc.

Third Party Software

A. This Canon product (the "PRODUCT") includes third-party software modules. Use and distribution of these software modules (the "SOFTWARE") are subject to the conditions below.

(1) You agree that you will comply with any applicable export control laws, restrictions or regulations of the countries involved in the event that this product including the SOFTWARE is shipped, transferred or exported into any country.

(2) Rights holders of the SOFTWARE retain in all respects the title, ownership and intellectual property rights in and to the SOFTWARE. Except as expressly provided herein, no license or right, expressed or implied, is hereby conveyed or granted by rights holders of the SOFTWARE to you for any intellectual property of rights holders of the SOFTWARE.

(3) You may use the SOFTWARE solely for use with the PRODUCT.

(4) You may not assign, sublicense, market, distribute, or transfer the SOFTWARE to any third party without prior written consent of rights holders of the SOFTWARE.

(5) Notwithstanding the foregoing, you may transfer the SOFTWARE only when (a) you assign to a transferee all of your rights to the PRODUCT and all rights and obligations under the conditions governing the SOFTWARE and PRODUCT and (b) such transferee agrees in writing to be bound by all these conditions.

(6) You may not decrypt, decompile, reverse engineer, disassemble or otherwise reduce the code of the SOFTWARE to human readable form.

(7) You may not modify, adapt, translate, rent, lease or loan the SOFTWARE or create derivative works based on the SOFTWARE.

(8) You are not entitled to remove or make separate copies of the SOFTWARE from the PRODUCT.

(9) The human-readable portion (the source code) of the SOFTWARE is not licensed to you.

B. Notwithstanding A above, in case any other license conditions accompany third-party software modules, these software modules are subject to these other conditions, as well.

ACCEPTANCE

THE TERMS OF THIS THIRD PARTY SOFTWARE STATED HERE OR IN RELATED WARRANTY PROVISIONS SHALL BE DEEMED ACCEPTED UPON YOUR USE OF THE PRODUCT FOR ONE OR MORE OF ITS NORMAL PURPOSES, IF THERE HAS BEEN NO OTHER PRIOR EXPRESS ACCEPTANCE.

THE TERMS OF THIS THIRD PARTY SOFTWARE GOVERN THE THIRD PARTY SOFTWARE AS DELIVERED WITH THE PRODUCT AND ALL UPDATED VERSIONS OF THE THIRD PARTY SOFTWARE PROVIDED UNDER MAINTENANCE AGREEMENTS OR OTHER SERVICE ARRANGEMENTS FOR THE PRODUCT WITH CANON USA OR CANON CANADA OR THEIR RESPECTIVE AUTHORIZED SERVICE ORGANIZATIONS.

The Software Subjected to Other Conditions

Please refer to eManual on a CD-ROM bundled with this product, for more detail and corresponding license conditions.

Disclaimers

The information in this document is subject to change without notice.

CANON INC. MAKES NO WARRANTY OF ANY KIND WITH REGARD TO THIS MATERIAL, EITHER EXPRESS OR IMPLIED, EXCEPT AS PROVIDED HEREIN, INCLUDING WITHOUT LIMITATION, THEREOF, WARRANTIES AS TO MARKETABILITY, MERCHANTABILITY, FITNESS FOR A PARTICULAR PURPOSE OF USE OR NON-INFRINGEMENT. CANON INC. SHALL NOT BE LIABLE FOR ANY DIRECT, INCIDENTAL, OR CONSEQUENTIAL DAMAGES OF ANY NATURE, OR LOSSES OR EXPENSES RESULTING FROM THE USE OF THIS MATERIAL.

For CA, USA only

Included battery contains Perchlorate Material - special handling may apply.

See <http://www.dtsc.ca.gov/hazardouswaste/perchlorate/> for details.

Legal Limitations on the Usage of Your Product and the Use of Images

Using your product to scan, print or otherwise reproduce certain documents, and the use of such images as scanned, printed or otherwise reproduced by your product, may be prohibited by law and may result in criminal and/or civil liability.

A non-exhaustive list of these documents is set forth below. This list is intended to be a guide only. If you are uncertain about the legality of using your product to scan, print or otherwise reproduce any particular document, and/or of the use of the images scanned, printed or otherwise reproduced, you should consult in advance with your legal advisor for guidance.

- Paper Money
- Money Orders
- Certificates of Deposit
- Postage Stamps (canceled or uncanceled)
- Identifying Badges or Insignias
- Selective Service or Draft Papers
- Checks or Drafts Issued by Governmental Agencies
- Motor Vehicle Licenses and Certificates of Title
- Travelers Checks
- Food Stamps
- Passports
- Immigration Papers
- Internal Revenue Stamps (canceled or uncanceled)
- Bonds or Other Certificates of Indebtedness
- Stock Certificates
- Copyrighted Works/Works of Art without Permission of Copyright Owner

FCC (Federal Communications Commission)

imageCLASS D550: F159400

This device complies with Part 15 of the FCC Rules. Operation is subject to the following two conditions:

- (1) This device may not cause harmful interference, and
- (2) This device must accept any interference received, including interference that may cause undesired operation.

This equipment has been tested and found to comply with the limits for a class B digital device, pursuant to Part 15 of the FCC Rules. These limits are designed to provide reasonable protection against harmful interference in a residential installation. This equipment generates, uses and can radiate radio frequency energy and, if not installed and used in accordance with the instructions, may cause harmful interference to radio communications. However, there is no guarantee that interference will not occur in a particular installation. If this equipment does cause harmful interference to radio or television reception, which can be determined by turning the equipment off and on, the user is encouraged to try to correct the interference by one or more of the following measures:

- Reorient or relocate the receiving antenna.
- Increase the separation between the equipment and receiver.
- Connect the equipment to an outlet on a circuit different from that to which the receiver is connected.
- Consult the dealer or an experienced radio/TV technician for help.

Use of shielded cable is required to comply with class B limits in Subpart B of Part 15 of the FCC Rules. Do not make any changes or modifications to the equipment unless otherwise specified in this manual. If you make such changes or modifications, you could be required to stop operation of the equipment.

Canon U.S.A., Inc.

One Canon Plaza, Lake Success, NY 11042, U.S.A.

TEL No. 1-800-OK-CANON

● Laser Safety

This machine complies with 21 CFR Chapter 1 Subchapter J as a Class 1 laser product under the U.S. Department of Health and Human Services (DHHS) Radiation Performance Standard according to the Radiation Control for Health and Safety Act of 1968. This means that the machine does not produce hazardous radiation.

Since radiation emitted inside the machine is completely confined within protective housings and external covers, the laser beam cannot escape from the machine during any phase of user operation.

CDRH Regulations

The Center for Devices and Radiological Health (CDRH) of the U.S. Food and Drug Administration implemented regulations for laser products on August 2, 1976. These regulations apply to laser products manufactured from August 1, 1976. Compliance is mandatory for products marketed in the United States.

CAUTION

Use of controls, adjustments, or performance of procedures other than those specified in this manual may result in hazardous radiation exposure.

The label is attached to the laser scanner machine inside the machine and is not in a user access area.



Before Using the Machine

This category describes the features of the machine and its useful functions.

Names and Functions on Each Part of the Machine	1-2
Front Side	1-2
Back Side	1-3
Interior	1-3
Multi-purpose Tray	1-4
Paper Cassette	1-4
Operation Panel	1-5
LCD (Standby Mode)	1-6
Copy Mode	1-6
Scan Mode	1-6
Navigating the Menu	1-7
Entering the Menu Screen	1-7
Scrolling Through Menu Items	1-7
Selecting a Menu Item	1-7
Specifying values using the navigation keys	1-8
Returning to the Default Screen	1-8
Text Input Method	1-9
Entering text, symbols, and numbers	1-9
Deleting text, symbols, and numbers	1-9
Setting the Sleep Timer	1-10
Setting the Current Date and Time	1-11

Names and Functions on Each Part of the Machine

This section describes the parts and functions of the machine.

Front Side

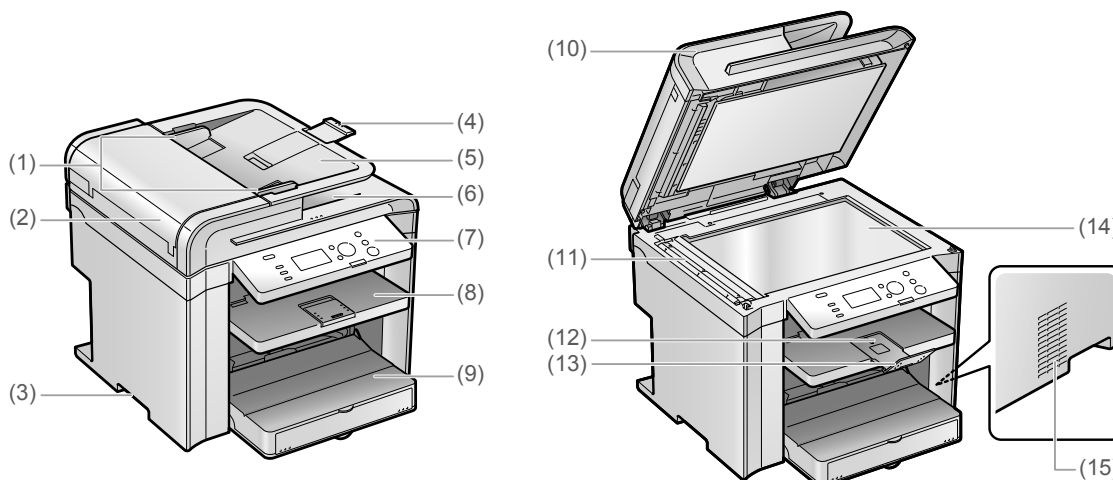

- (1) Document guides**
Adjust to the width of the document.
- (2) Feeder cover**
Open this cover to clear paper jams.
- (3) Lift handles**
Hold this handle to lift or transport the machine.
- (4) Tray extension**
Pull out the tray extension when the paper is hanging out of the document feeder tray such as Legal size paper.
- (5) Document feeder tray**
Place documents here.
- (6) Document return tray**
Documents are returned here.
- (7) Operation panel**
Controls the machine using this panel.
▶ "Operation Panel" (→P.1-5)
- (8) Output tray**
Copies and printed documents are output here.
- (9) Paper cassette**
Load paper here.
▶ "Paper Cassette" (→P.1-4)
- (10) Feeder**
The feeder can automatically scan documents continuously.
- (11) Scanning area**
Scans documents from the feeder.
- (12) Output tray extension**
Extends the tray for large paper sizes.
- (13) Paper stopper**
Prevents paper from falling from the output tray.
- (14) Platen glass**
Place a document here.
- (15) Ventilation slots**
Allows inside of the machine to cool down.
Leave enough space around the machine to allow heat to escape sufficiently.

Back Side

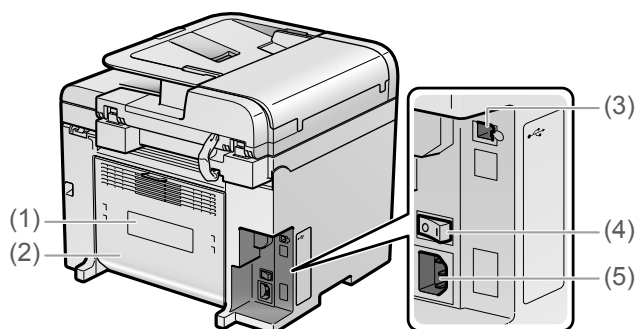

(1) Rating label

The average values of the required voltage and current are specified.

(2) Rear cover

Open this cover to clear paper jams.

(3) USB port

Connect to a computer via a USB cable.

(4) Power switch

Turn the power ON or OFF.

(5) Power socket

Connect the power cord.

Interior

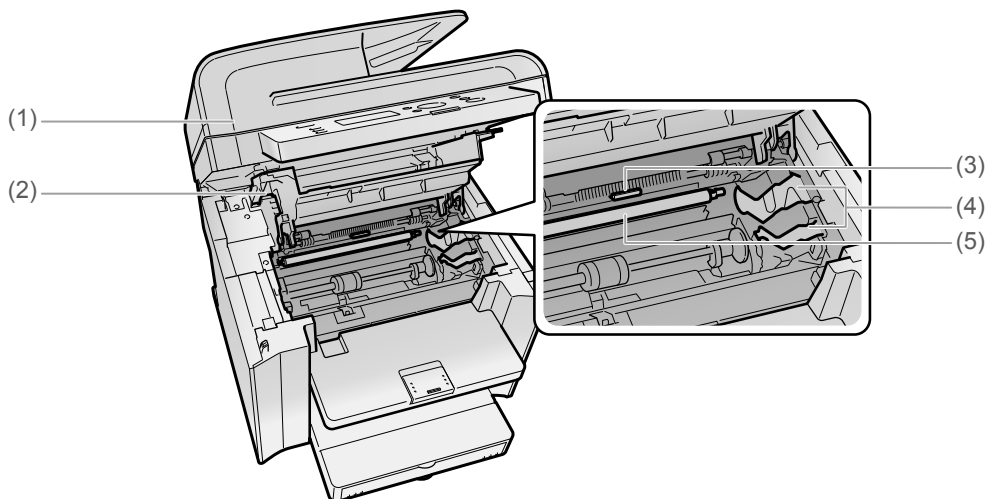

(1) Scanning platform

Open this platform to replace the toner cartridge or clear paper jams.

(2) Toner cover

Open this cover to replace the toner cartridge or clear paper jams.

(3) Paper exit guide

Open this guide to clear paper jams.

(4) Toner guides

When inserting the toner cartridge, fit the protrusions on the toner cartridge into these guides.

(5) Transfer roller

Transfers toner onto paper.

Multi-purpose Tray

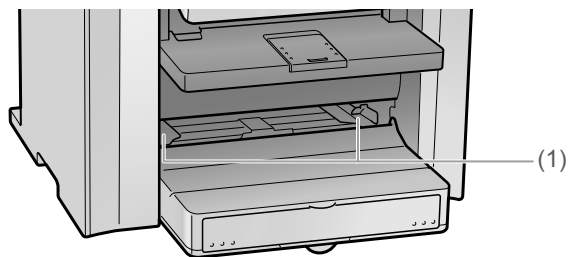

- (1) **Paper guides**
Adjust to the width of the paper.

Paper Cassette

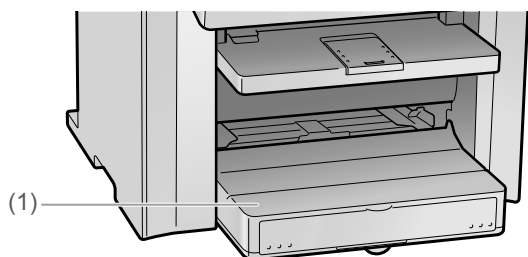

- (1) **Dust cover**
Protects paper in the paper cassette from dirt and dust.

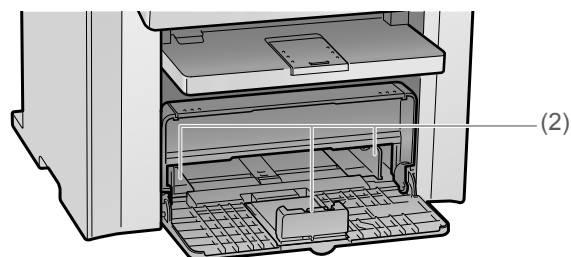

- (2) **Paper guides**
Adjust the paper guides to the paper.

Operation Panel

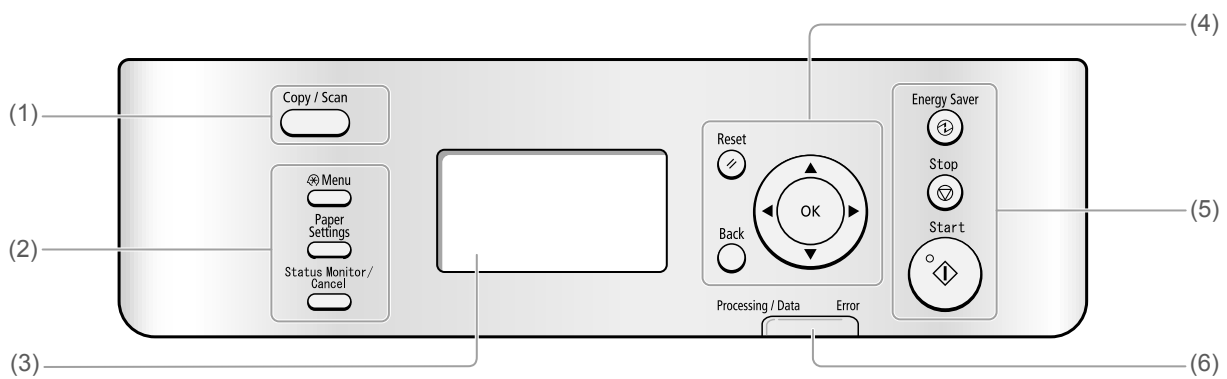

(1)	Mode switching keys	Press to switch the mode to copy or scan.
(2)	[Menu] key	Press to specify or register various settings.
	[Paper Settings] key	Press to specify paper size and type for the paper cassette or multi-purpose tray.
	[Status Monitor/Cancel] key	Press to view or cancel jobs. You can also check the status of the machine.
(3)	LCD	During normal operation, displays messages and prompts. When adjusting the settings, displays your selections, text, and numbers.
(4)	[Reset] key	Press to reset the settings. (Press to reset the copy or scan mode to the standard mode.)
	[Back] key	Press to return to the previous screen.
	[▲] key	Press to scroll up or to increase a value.
	[▼] key	Press to scroll down or to decrease a value.
	[◀] key	Press to return to the previous screen or move the cursor to the left.
	[▶] key	Press to proceed to the next screen or move the cursor to the right.
(5)	[OK] key	Press to confirm an action or setting.
	[Energy Saver] key	Press to manually set or cancel the Sleep mode. The Energy Saver light will be green when in Sleep mode.
	[Stop] key	Press to cancel jobs.
(6)	[Start] key	Press to start copying or scanning.
	[Processing/Data] indicator	The indicator blinks while processing jobs and remains lit when jobs are waiting in memory.
	[Error] indicator	The indicator blinks when an error occurs.

LCD (Standby Mode)

This section describes the following screens.

- Copy Mode
- Scan Mode



NOTE

Display of the standby mode

- You can change the standby display which appears when the power switch is turned ON.
 - ☞ e-Manual → Basic Operation → Customizing Display
Settings → Setting the Default Screen
- When the machine is idle for 2 minutes, the display returns to standby mode.
 - ☞ e-Manual → Basic Operation → Customizing Timer Settings
→ Specifying the Auto Reset Timer

Copy Mode

When using the copy function, press [] to switch to the standby display.

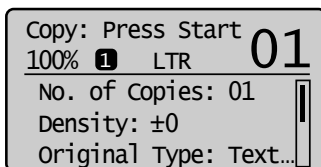

When the copy mode screen is displayed, you can select items by pressing [▲] or [▼]. The currently selected item will be highlighted with a black background, and pressing [OK] will advance to the next screen.

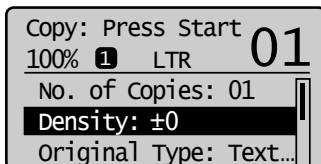

Scan Mode

When using the scan function, press [] to switch to the standby display.

When the scan mode screen is displayed, you can select items by pressing [▲] or [▼]. The currently selected item will be highlighted with a black background, and pressing [OK] will advance to the next screen.

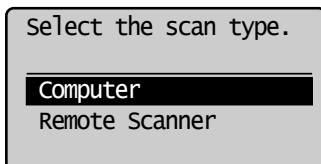

Navigating the Menu

This section describes how to navigate the menu and specify values on the menu screen.

Keys to be used for this operation

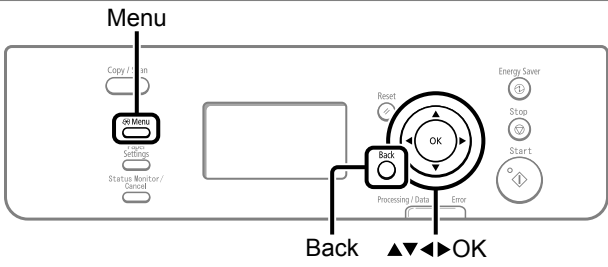

Entering the Menu Screen

Press [] (Menu) to enter the menu screen.

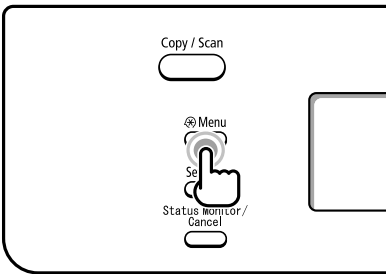

Scrolling Through Menu Items

The scrollbar at the right side of the screen indicates that more items are available.

To select an item that is not shown on the screen, press [▲] or [▼] to scroll through menu items.

The currently selected item is highlighted with a black background.

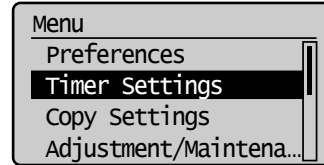

Selecting a Menu Item

Press [OK] to select a highlighted menu.

If there are submenus available, you can also press [▶] to select the item and proceed to the next screen.

You can return to the previous screen by pressing [○] (Back) or [◀].

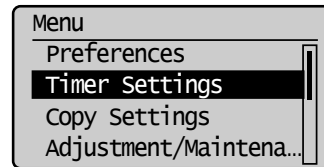

[OK] or [▶] ↓ ↑ [Back] or [◀]

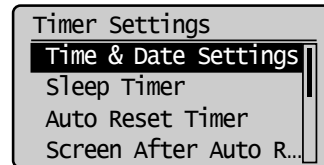

Specifying values using the navigation keys

Specifying values

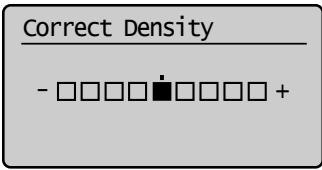
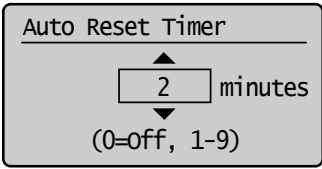
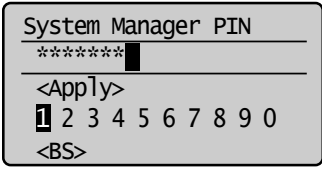
Situation	Screen example	Procedure
When moving through the bars to adjust levels such as density		Press [◀] or [▶] to adjust the level.
When selecting a value to set a timer		Press [▲] or [▼] to specify the value. NOTE Available values You can specify any value shown in the parentheses at the bottom of the screen.
When entering a series of numbers or letters such as PIN		Press [◀], [▶], [▲], or [▼] to select a number or character, and then press [OK] to enter the number or character. To clear a number or character, select <BS>, and then press [OK].

Confirming the input

To confirm the input:

- Press [OK].
- When <Apply> appears on the display, press [▲] or [▼] to select <Apply>, and then press [OK].

Returning to the Default Screen

From the menu screen, press [] (Menu) to exit the menu screen and return to the default screen.

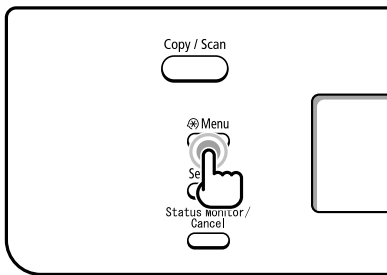

NOTE

If you press [] (Menu) before you press [OK]

The specified settings will not be saved.

Text Input Method

Enter information (text, symbols, and numbers) into the machine using the following keys.

Keys to be used for this operation

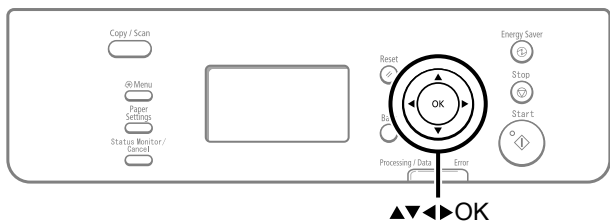

Entering text, symbols, and numbers

Press [\blacktriangleleft] or [\blacktriangleright] to select a character, symbol, or number, and then press [OK].

Deleting text, symbols, and numbers

Press [\blacktriangledown] to select <BS>, and then press [OK].

Example: Enter $\langle 1234 \rangle$.

- 1 Press [\blacktriangleleft] or [\blacktriangleright] to select $\langle 1 \rangle$, and then press [OK].

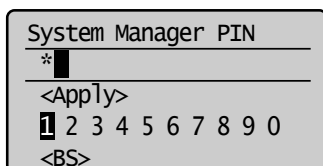

- 2 Press [\blacktriangleleft] or [\blacktriangleright] to select $\langle 2 \rangle$, and then press [OK].

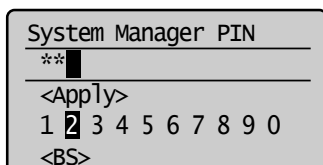

- 3 Press [\blacktriangleleft] or [\blacktriangleright] to select $\langle 3 \rangle$, and then press [OK].

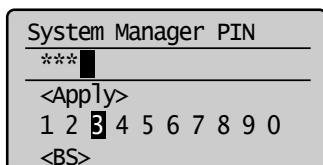

- 4 Press [\blacktriangleleft] or [\blacktriangleright] to select $\langle 4 \rangle$, and then press [OK].

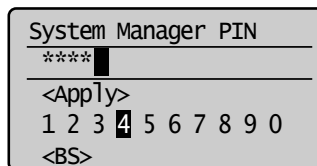

- 5 Press [\blacktriangleup] or [\blacktriangledown] to select $\langle \text{Apply} \rangle$, and then press [OK].

The entry is applied.

Setting the Sleep Timer

The machine returns to sleep mode automatically when it is idle for a specified length of time.

Keys to be used for this operation

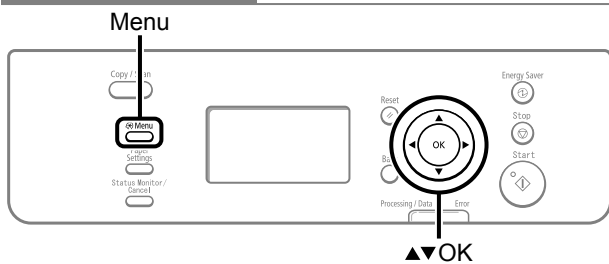

- 1 Press [] (Menu).
- 2 Press [▲] or [▼] to select <Timer Settings>, and then press [OK].

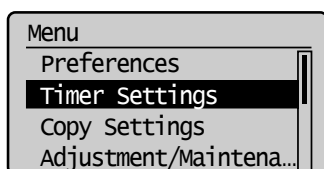

- 3 Press [▲] or [▼] to select <Sleep Timer>, and then press [OK].

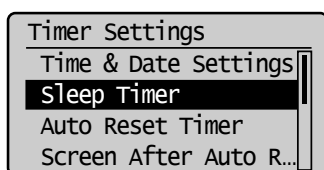

- 4 Press [▲] or [▼] to specify the time, and then press [OK].

* We recommend that you use this option in the default setting.

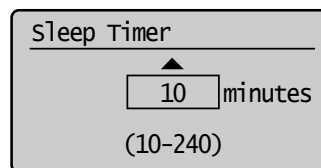

NOTE

Specifying the auto sleep timer

You may specify the auto sleep timer between <10> minutes and <240> minutes, in one minute interval. The default value for this setting is <10> minutes.

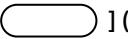
- 5 Press [] (Menu) to close the menu screen.

NOTE

When entering sleep mode

[] (Energy Saver) will be lit green.

To enter sleep mode manually

Press [] (Energy Saver).

* The machine does not enter the sleep mode, if you press [] (Energy Saver) in 10 seconds after the machine resumes from the sleep mode.

The machine will not enter sleep mode when

- the machine is in operation
- the Processing/Data indicator is lit or blinking
- a message appears on the display and the Error indicator blinks
- the machine is performing adjustment or cleaning
- there is a paper jam
- documents are set in the feeder

The machine will wake from sleep mode when

- you press [] (Energy Saver)
- a print job from a computer begins
- documents are set in the feeder
- the machine is connected to a computer via a USB cable

Setting the Current Date and Time

Specify a display format for the date and time and set the current date and time.
The specified date and time are used for reports.

Keys to be used for this operation

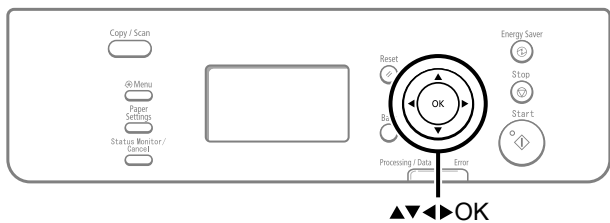

- 1 Press [] (Menu).
- 2 Press [▲] or [▼] to select <Timer Settings>, and then press [OK].

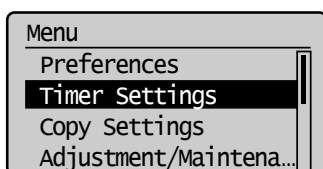

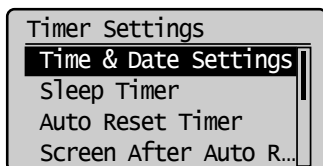

- 3 Press [▲] or [▼] to select <Time & Date Settings>, and then press [OK].

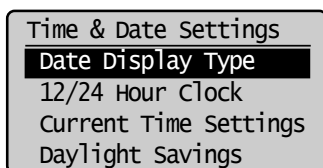

- 4 Press [▲] or [▼] to select a setting item, and then press [OK].

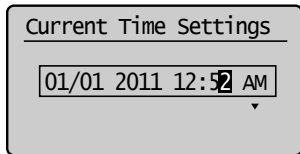

Settings	Overview	Operation
<Date Display Type>	Specifies the display format for dates.	Press [▲] or [▼] to select one of following display formats, and then press [OK]. You can select a display format from the following three options. • MM/DD/YYYY • DD/MM/YYYY • YYYY MM/DD
<12/24 Hour Clock>	Specifies the display format for time.	Press [▲] or [▼] to select a display format, and then press [OK]. You can select a display format from the following two options. • 12 Hour (AM/PM) • 24 Hour
<Current Time Settings>	Specifies the current time and date.	Enter the date and time, and then press [OK]. ☒ "Text Input Method"(P.1-9) Press [▲] or [▼] to switch between <AM> and <PM>. 
<Daylight Savings>	Specifies the daylight savings time.	To use daylight savings time, 1. Press [▲] or [▼] to select <On>, and then press [OK]. 2. Specify the starting date of the daylight savings time. - Press [▲] or [▼] to select <Month>, and then press [OK]. - Select the starting month, and then press [OK]. - Press [▲] or [▼] to select <Day>, and then press [OK]. - Select the starting week, and then press [OK]. - Select the starting day, and then press [OK]. - Press [▲] or [▼] to select <Apply>, and then press [OK]. 3. Repeat step 2 to specify the ending date.

- 5 Press [] (Menu) to close the menu screen.

Document and Paper Handling

Document Requirements	2-2
Scanning Range	2-3
Copy	2-3
Scan	2-3
Placing Documents	2-4
Placing Documents on the Platen Glass	2-4
Loading Document in the Feeder	2-4
Paper Requirements	2-6
Paper Size	2-6
Paper Type	2-7
Printable Range	2-8
Loading Paper	2-9
In the Paper Cassette	2-9
In the Multi-Purpose Tray	2-11
Precautions when Loading Paper	2-12
Paper Loading Capacity	2-12
Paper Loading Orientation	2-13
When printing paper with a letterhead or logo (previously printed paper)	2-13
Printing on Envelopes	2-13
Setting a Paper Size and Type	2-14
Setting a Custom Paper Size	2-14
Selecting Print Side	2-16
When setting this item to <Print Speed Priority> (the default setting)	2-16
When setting this item to <Print Side Priority>	2-16

Document Requirements

	Platen glass	Feeder
Document type	<ul style="list-style-type: none"> • Plain paper • Heavy paper • Photograph • Small documents (e.g., index cards) • Special types of paper (e.g., tracing paper, transparencies, etc.) ^{*1} • Booklet (Up to 3/4" (20 mm) thickness) 	Plain paper (Multi-page documents of the same size, thickness and weight/onepage documents)
Size (W x L)	Maximum 8 1/2" x 11 3/4" (215.9 mm x 297 mm)	Maximum 8 1/2" x 14" (216 mm x 356 mm) Minimum 5 1/2" x 5" (140 mm x 127 mm)
Weight	Maximum 4.4 lb (2 kg)	<ul style="list-style-type: none"> • 1-sided documents 13.3 to 27.9 lb Bond (50 to 105 g/m²) • 2-sided documents 16.0 to 27.9 lb Bond (60 to 105 g/m²)
Paper Capacity	1 sheet	Maximum 50 sheets ^{*2}

^{*1} When copying transparent documents such as tracing paper or transparencies, use a piece of plain white paper to cover the document after placing it face-down on the platen glass.

^{*2} 21 lb Bond (80 g/m²) paper



IMPORTANT

When placing document

Place the document after glue, ink or correction fluid on the document is completely dry.

To prevent paper jams in the feeder

Do not use any of the following.

- Wrinkled or creased paper
- Carbon paper or carbon-backed paper
- Curled or rolled paper
- Coated paper
- Torn paper
- Onion skin or thin paper
- Documents with staples or paper clips attached
- Paper printed with a thermal transfer printer
- Transparency

● Scanning Range

Ensure your document's text and graphics fall within the area specified in the following diagram.

* Note that the margin widths listed below are rough standards and there may be slight variations in actual use.

* The loading orientation of documents is as follows.

- Platen glass: With the document facing down
- Feeder: With the document loaded in the document feeder tray

Copy

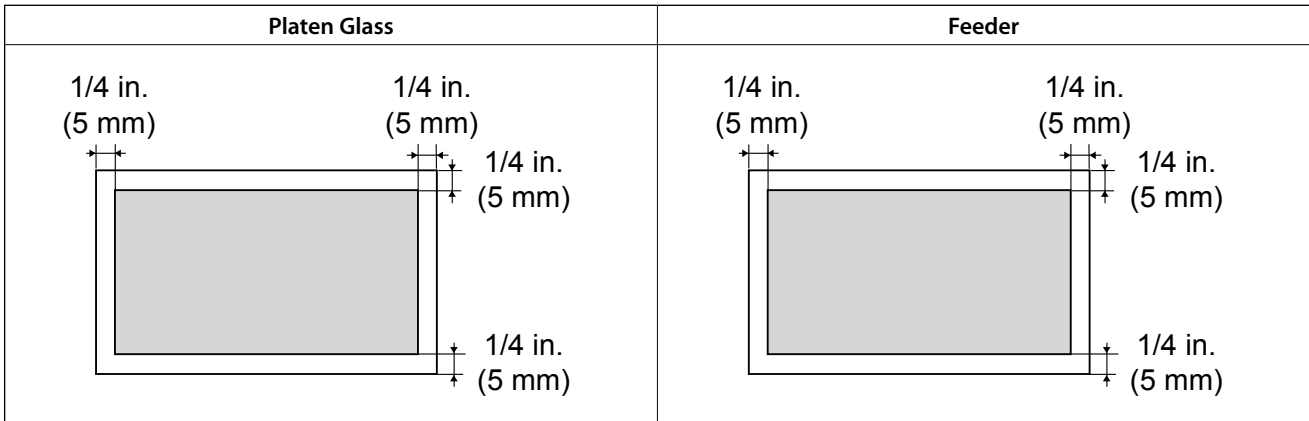

Scan

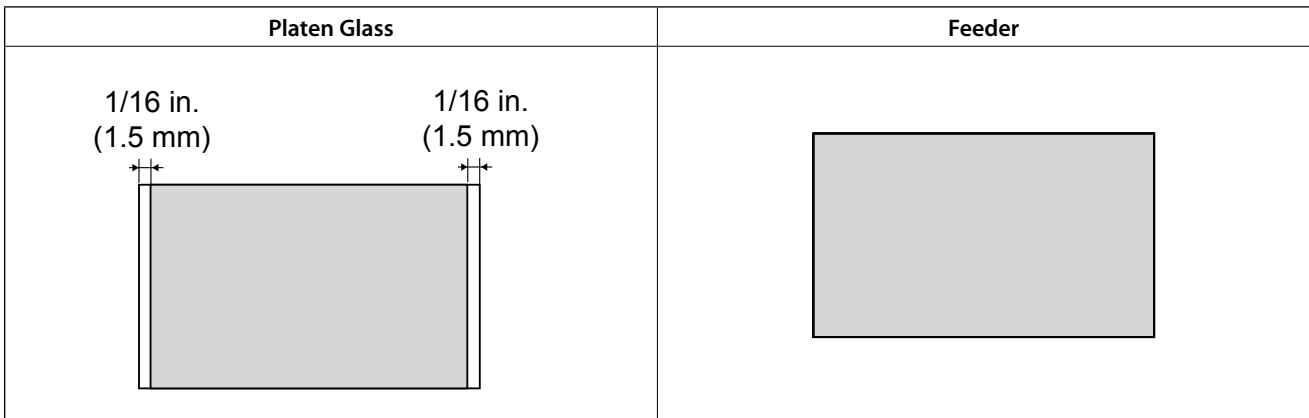

Placing Documents

This section describes placing the documents on the platen glass or loading them in the feeder.

Placing Documents on the Platen Glass

- 1 Open the feeder.

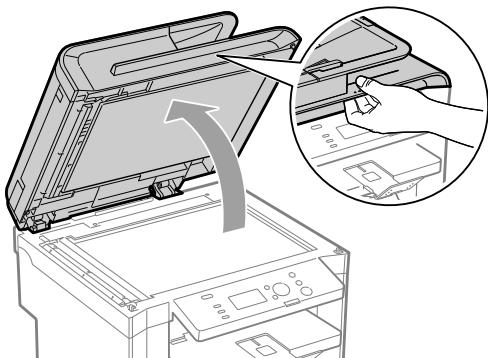

- 2 Place a document face down.

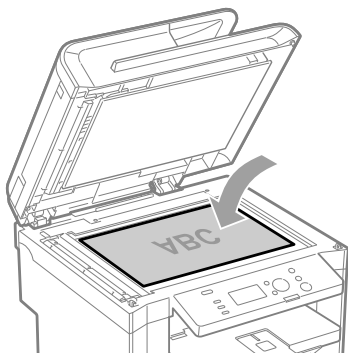

- 3 Align the document with the appropriate paper size marks.

If your document does not match any of the paper size marks, align the center of your document with the arrow mark.

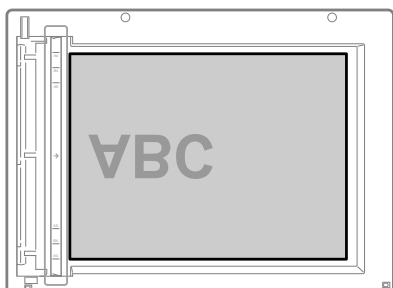

- 4 Close the feeder gently.

The machine is ready to scan the document.

When scanning is complete, remove the document from the platen glass.

CAUTION

Precautions when closing the feeder

- Be careful not to get your fingers caught. This may cause personal injury.
- Do not press down the feeder forcefully. This may damage the platen glass and cause personal injury.

Loading Document in the Feeder

- 1 Spread the document guides a little wider than the document width.

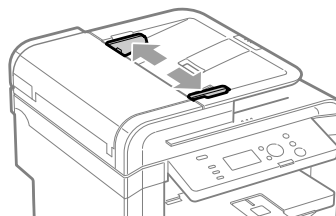

- 2 If loading large-sized documents, pull out the tray extension.

Pull out the tray extension when the document is hanging out of the document feeder tray.

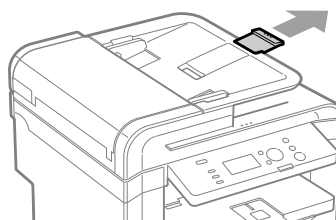

3 Fan the document stack and align the edges of the pages.

Thoroughly fan in small batches

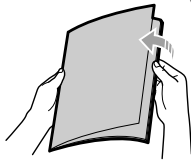

Align the edges on a flat surface a few times

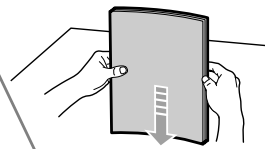

4 Neatly place the documents face up.

- Load the document under the load limit guides (A).
- Ensure that the paper stack does not exceed the load limit marks (B).

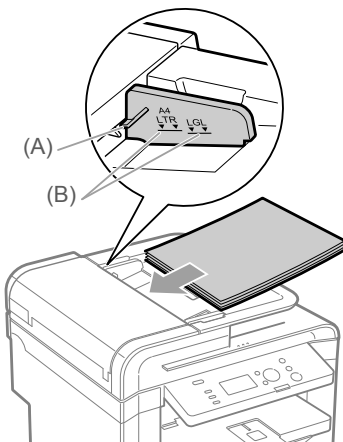

5 Align the document guides to fit the width of the document.

The machine is ready to scan the document.

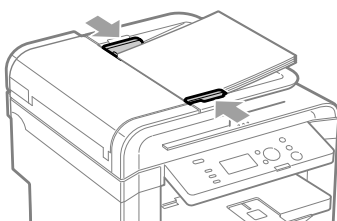

IMPORTANT

Up to 50 documents can be loaded

If more than 50 documents are loaded, paper jams may occur, or the documents may not be scanned.

While scanning a document

Do not add or remove documents.

When scanning documents is complete

Remove the documents from the document delivery tray to avoid paper jams.

Avoid scanning the same document more than 30 times.

When scanned repeatedly, documents can become folded or torn, which may cause paper jams.

Be sure to align the document guides with the width of the paper

- If the document guides are too loose or too tight, this may result in misfeeds or paper jams.
- Printouts may be askew depending on the printing environment. Properly load paper to reduce the symptom.

Paper Requirements

Paper Size

The available paper sizes are as follows.

○ : Available — : Not available

Paper size	Paper source	
	Paper cassette	Multi-purpose tray
A4 (8 1/4" x 11 3/4" (210 mm x 297 mm)) *1	○	○
B5 (7 1/8" x 10 1/8" (182 mm x 257 mm))	○	○
A5 (5 7/8" x 8 1/4" (148 mm x 210 mm))	○	○
Legal (8 1/2" x 14" (216 mm x 356 mm)) *1	○	○
Letter (8 1/2" x 11" (216 mm x 279 mm)) *1	○	○
Statement (5 1/2" x 8 1/2" (140 mm x 216 mm))	○	○
Executive (7 1/4" x 10 1/2" (184 mm x 267 mm))	○	○
Officio (8 1/2" x 12 1/2" (216 mm x 318 mm)) *1	○	○
B-officio (8 1/2" x 14" (216 mm x 355 mm)) *1	○	○
M-officio (8 1/2" x 13 3/8" (216 mm x 341 mm)) *1	○	○
Government - Letter (8" x 10 1/2" (203 mm x 267 mm))	○	○
Government - Legal (8" x 13" (203 mm x 330 mm))	○	○
Foolscap (8 1/2" x 13" (216 mm x 330 mm)) *1	○	○
A-foolscap (8 1/8" x 13 3/8" (206 mm x 338 mm))	○	○
Envelope COM10 (4 1/8" x 9 1/2" (104.7 mm x 241.3 mm)) *2	○	○
Envelope Monarch (3 7/8" x 7 1/2" (98.4 mm x 190.5 mm)) *2	—	○
Envelope C5 (6 3/8" x 9" (162 mm x 229 mm)) *2	○	○
Envelope B5 (6 7/8" x 9 7/8" (176 mm x 250 mm)) *2	○	○
Envelope DL (4 3/8" x 8 5/8" (110 mm x 220 mm)) *2	○	○
Index Card (3" x 5" (76 mm x 127 mm))	—	○
Custom Paper Size	○ *3	○ *4

*1 Auto 2-sided print is available.

*2 Use envelopes with the flap closed.

*3 You can load paper of the following custom paper sizes.

* Width 3" to 8 1/2" (76.2 to 216 mm); Length 8 1/4" to 14" (210 to 356 mm)

*4 You can load paper of the following custom paper sizes.

* Width 3" to 8 1/2" (76.2 to 216 mm); Length 5" to 14" (127 to 356 mm)



NOTE

Default paper size

The default paper size is Letter. If you use a different paper size, change the paper size settings.

☑ "Setting a Paper Size and Type" (→P.2-14)

Paper Type

The available paper types are as follows.

Paper Type		Printer Driver Setting	Paper Source	
			Paper Capacity (Paper Cassette)	Paper Capacity (Multi-purpose Tray)
Plain paper ^{*1}	16 to 21 lb Bond (60 to 80 g/m ²)	[Plain Paper]	250 sheets	1 sheet
	21 to 24 lb Bond (80 to 90 g/m ²)	[Plain Paper L] ^{*2}	170 sheets	
Heavy paper	24 to 28 lb Bond (90 to 105 g/m ²)	[Heavy Paper 1]	170 sheets	1 sheet
	28 to 32 lb Bond (105 to 120 g/m ²)		100 sheets	1 sheet
	45 to 60 lb Cover (120 to 163 g/m ²)	[Heavy Paper 2]	100 sheets	1 sheet
Rough paper	16 to 24 lb Bond (60 to 90 g/m ²)	[Rough Paper 1]	100 sheets	1 sheet
	24 to 32 lb Bond (90 to 120 g/m ²)	[Rough Paper 2]	100 sheets	1 sheet
	45 to 60 lb Bond (120 to 163 g/m ²)	[Rough Paper 3]	100 sheets	1 sheet
Recycled paper ^{*1}	16 to 21 lb Bond (60 to 80 g/m ²)	[Recycled Paper]	250 sheets	1 sheet
Color paper ^{*1}	16 to 21 lb Bond (60 to 80 g/m ²)	[Color Paper]	250 sheets	1 sheet
Transparency ^{*3}		[Transparency]	50 sheets	1 sheet
Label		[Labels]	100 sheets	1 sheet
Index Card		[Index Card]	Not available	1 sheet
Envelope ^{*4}		[Envelope]	20 envelopes	1 envelope

^{*1} Auto 2-sided print is available.

^{*2} If printed paper curls when [Plain Paper] is selected, set paper type to [Plain Paper L]. However, the toner fixation may be not as good when [Plain Paper L] is set.

^{*3} Use only the transparencies designed for laser printers.

^{*4} You can set Envelope Monarch only in the multi-purpose tray.

To prevent paper jams, do not use the following types of paper.

- Wrinkled or creased paper
- Curled or rolled paper
- Torn paper
- Damp paper
- Very thin paper
- Paper printed with a thermal transfer printer (Do not copy on the reverse side.)

The following types of paper do not print well:

- Highly textured paper
- Very smooth paper
- Glossy paper

Make sure the paper is free from dust, lint, and oil stains.

Make sure to test paper before purchasing large quantities.

Store all paper wrapped and on a flat surface until ready

for use. Keep opened packs in their original packaging in a cool, dry location.

Store paper at 64.4 to 75.2°F (18 to 24°C), 40 % to 60 % RH.

CAUTION

If you print on damp paper

The following problems may occur.

- Steam is emitted from the printer output area.
- Water droplets form on the back side of the operation panel and in the output area.

Because moisture in the paper is evaporating due to the heat generated when toner fixes, this is not a malfunction. (This is likely to occur when the room temperature is low.)

If you smell a burnt odor, however, immediately turn OFF the machine, unplug the power plug from the AC power outlet, and then contact your local authorized Canon dealer or the Canon help line. Continued use can result in a fire or electrical shock.

Printable Range

The shaded area indicates the approximate printable area of A4 paper. Note that the margin widths listed below are rough standards and there may be slight variations in actual use.

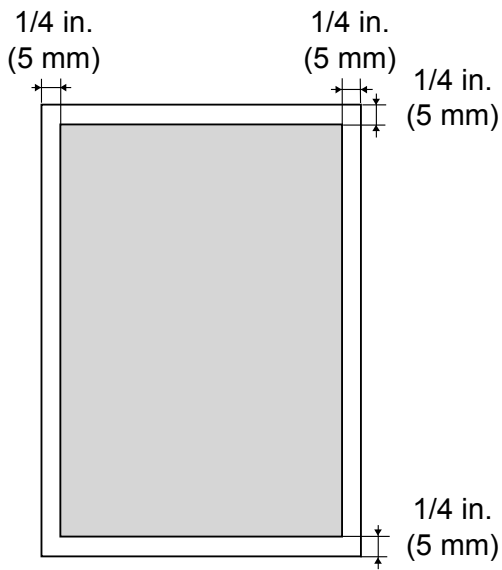

Loading Paper

This section describes how to load paper in the paper cassette and the multi-purpose tray.

NOTE -----

If you use paper of a different size or type

The default paper size/type is set to <Letter> and <Plain (16 lb Bond-24 lb Bond)> in the setting menu. If you use a different paper size or paper type, you need to change the paper settings.

- ▶ "Setting a Paper Size and Type" (→P.2-14)

In the Paper Cassette

Before loading paper in the paper cassette, see "Precautions when Loading Paper" (→P.2-12).

1 Lift the dust cover.

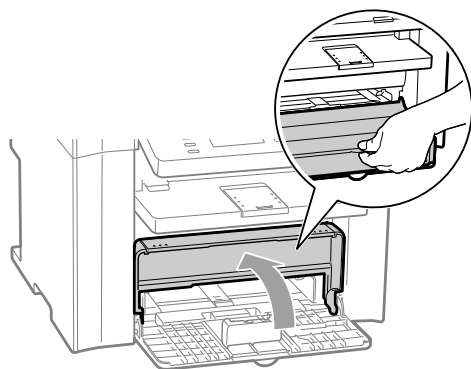

2 Spread the paper guides a little wider than the paper size.

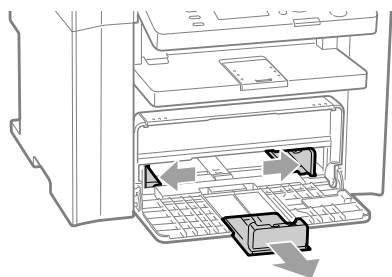

* If you want to change the size of the paper to be loaded, be sure to register the paper size in "Setting a Paper Size and Type" (→P.2-14).

3 Gently load the paper into the paper cassette with the print side face up, until the edge of the paper stack meets the back of the paper cassette.

- ▶ "Paper Loading Capacity" (→P.2-12)
- ▶ "Paper Loading Orientation" (→P.2-13)

Ensure that the paper stack does not exceed the load limit guides (A).

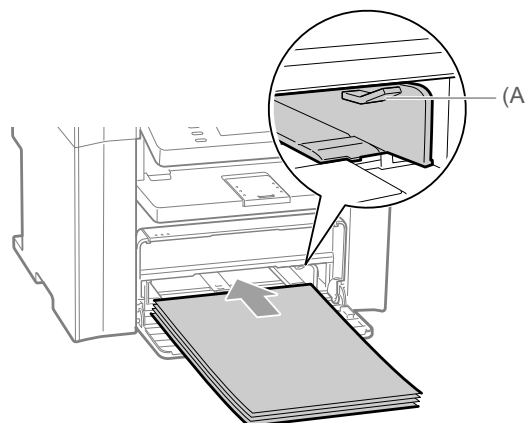

When loading envelopes

- (1) Close the envelope flap.

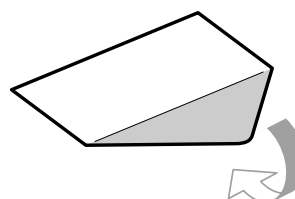

- (2) Place the stack of envelopes on a flat surface, flatten them to release any remaining air, and ensure that the edges are pressed tightly.

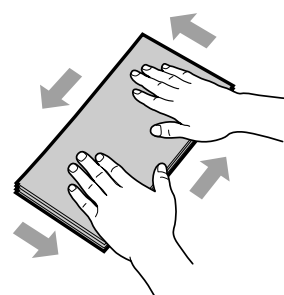

- (3) Loosen any stiff corners of the envelopes and flatten curls as shown in the figure.

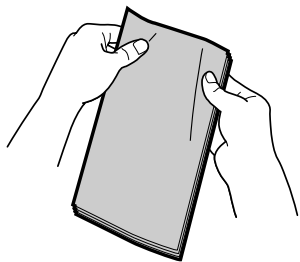

- (4) Align the edges of the envelopes on a flat surface.

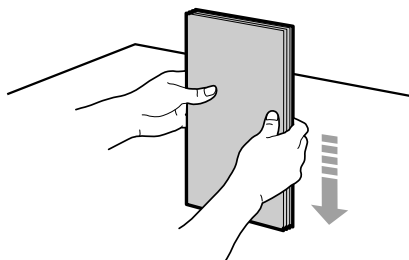

- (5) Gently load the envelopes into the paper cassette with the print side face up, until the edge of the envelope stack meets the back of the paper cassette.

4 Adjust the paper guides to the width of the paper.

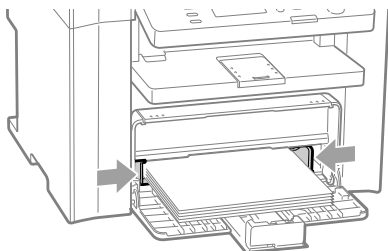

5 Adjust the paper guide to the length of the paper.

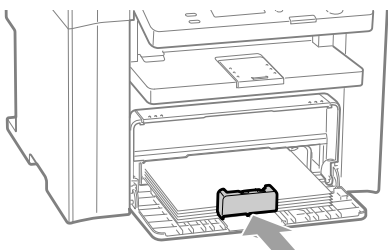

6 Close the dust cover.

When loading paper that is longer than the length of the paper cassette

Lift the dust cover extension.

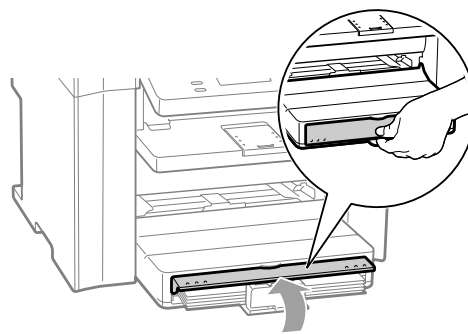

7 Pull out the output tray extension, and then lift the paper stopper.

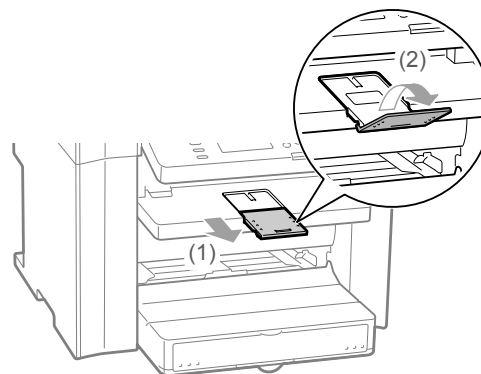

8 Specify the loaded paper size and type.

☑ "Setting a Paper Size and Type" (→P.2-14)

In the Multi-Purpose Tray

Before loading paper in the multi-purpose tray, see "Precautions when Loading Paper" (→P.2-12).

Use the multi-purpose tray when you want to copy or print on a paper that is different from what is in the paper cassette. You can load a single sheet of paper in the multi-purpose tray.

- 1 Spread the paper guides a little wider than the paper.

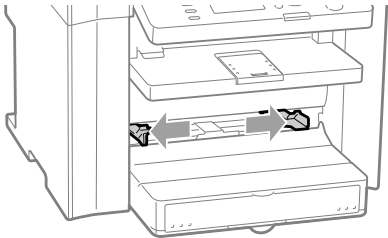

- 2 Gently insert the paper into the multi-purpose tray with the print side face up.

▶ "Paper Loading Capacity" (→P.2-12)

▶ "Paper Loading Orientation" (→P.2-13)

Ensure that the paper stack does not exceed the load limit guides (A).

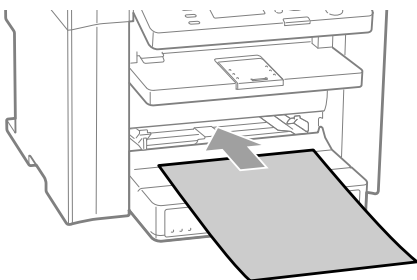

When loading envelopes

- (1) Close the envelope flap.

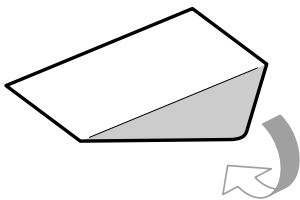

- (2) Loosen any stiff corners of the envelope and flatten curls as shown in the figure.

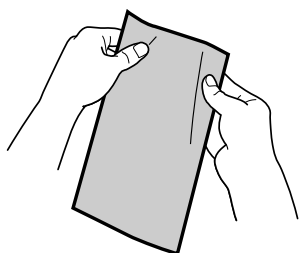

- (3) Gently insert the envelope into the multi-purpose tray with the print side face up.

- 3 Adjust the paper guides to the paper.

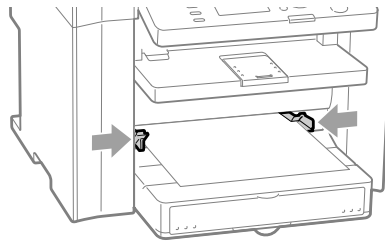

- 4 Pull out the output tray extension, and then lift the paper stopper.

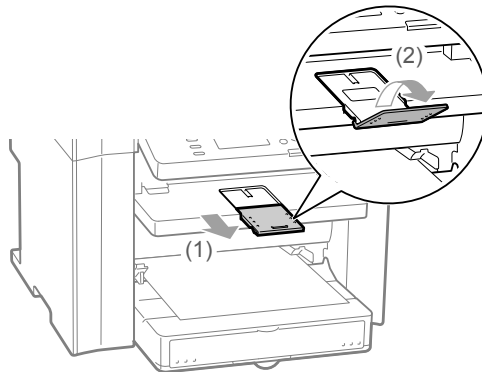

- 5 Specify the loaded paper size and type.

▶ "Setting a Paper Size and Type" (→P.2-14)

Precautions when Loading Paper

CAUTION

Be careful when handling paper

Handle paper carefully not to cut your hands with the edges of the paper.

Precautions when inserting the paper cassette

Be careful not to catch your fingers.

IMPORTANT

Be sure to align the paper guides with the width of the paper.

- If the paper guides are too loose or too tight, this may result in misfeeds or paper jams.
- Printouts may be askew depending on the printing environment. Properly load paper to reduce the symptom.

When using paper that has been poorly cut

If you use paper that has been poorly cut, multiple sheets of paper may be fed at once. In this case, fan the paper thoroughly, and then align the edges of the stack properly on a hard, flat surface.

Do not exceed the load limit mark when loading paper.

Ensure that the paper stack does not exceed the line of the load limit mark. If the paper stack exceeds the load limit mark lines, this may result in misfeeds.

When printing on envelopes

Load envelopes with the front side (non-glued side) facing up. You cannot print on the reverse side of envelopes.

Also, be sure to close the flap before loading envelopes.

NOTE

Detailed information about usable paper

 "Paper Requirements" (→P.2-6)

Size abbreviation on the paper guides of the paper cassette

Paper size	Paper guide
Legal	LGL
Letter	LTR
Executive	EXEC

Paper Loading Capacity

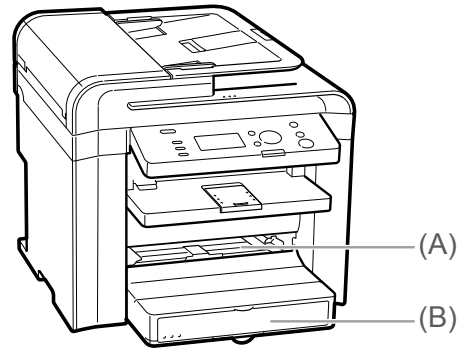

Paper type	Paper source	
	(A) Multi-purpose tray	(B) Paper cassette
Plain paper (Ex. 21 lb Bond (80 g/m ²))	1 sheet	Approx. 250 sheets
Heavy paper (Ex. 25 lb Bond (91 g/m ²))	1 sheet	Approx. 170 sheets
Heavy paper (Ex. 34 lb Bond (128 g/m ²))	1 sheet	Approx. 100 sheets
Transparency	1 sheet	Approx. 50 sheets
Label	1 sheet	Approx. 100 sheets
Envelope	1 envelope	Approx. 20 envelopes

Paper Loading Orientation



NOTE

Paper loading orientation when loading in the multi-purpose tray

Paper loading orientation for the multi-purpose tray is same as which for the paper cassette.

When printing paper with a letterhead or logo (previously printed paper)

Load the paper as shown below.

(➡: Feeding direction)

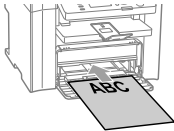
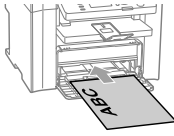
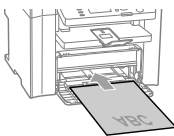
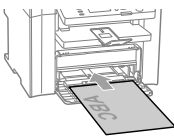
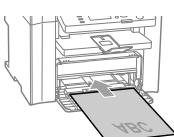
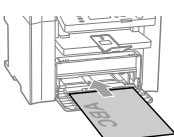
	Portrait layout	Landscape layout
1-sided printing ^{*1}	 <p>(with the printed side face up)</p>	 <p>(with the printed side face up)</p>
1-sided printing ^{*2}	 <p>(with the printed side face down)</p>	 <p>(with the printed side face down)</p>
Automatic 2-sided printing	 <p>(with the front side face down)</p>	 <p>(with the front side face down)</p>

^{*1} When <Paper Feed Method Switch> is set to <Print Speed Priority> (the default setting)

➡ "Selecting Print Side" (→P.2-16)

^{*2} When <Paper Feed Method Switch> is set to <Print Side Priority>

➡ "Selecting Print Side" (→P.2-16)

Printing on Envelopes

Load envelopes with the front side (non-glued side) facing up as follows.

(➡: Feeding direction)

Envelope, No.10, DL, ISO-C5

Load the envelopes so that the flap is toward the left of the paper cassette when they are viewed from the front.

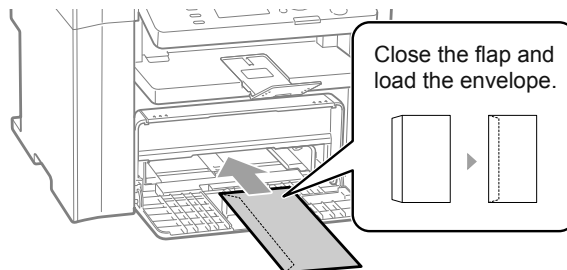

Envelope ISO-B5

Load the envelopes so that the flap is toward the back of the paper cassette when they are viewed from the front.

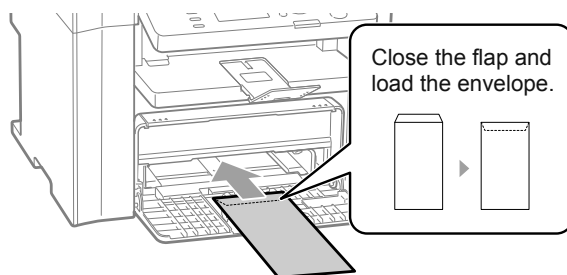

Setting a Paper Size and Type

Whenever you change the paper size and type loaded in the cassette or tray, follow the procedure in this section to adjust the paper size and type settings.



IMPORTANT

If the setting is different from the size of the loaded paper

An error message appears, or printing is not performed correctly.

Keys to be used for this operation

Paper Settings

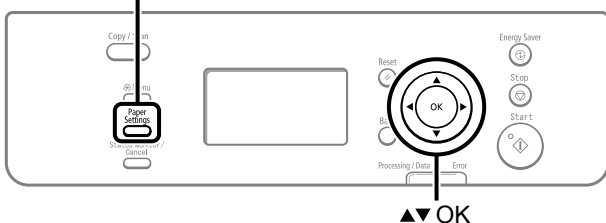

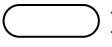
- 1 Press [] (Paper Settings).
- 2 Press [▲] or [▼] to select <MP Tray> or <Drawer 1>, and then press [OK].

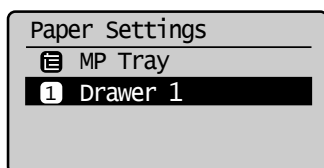

- 3 Press [▲] or [▼] to select a paper size, and then press [OK].

☑ "Paper Requirements" (→P.2-6)

* When registering the custom paper, see "Setting a Custom Paper Size" (→P.2-14).

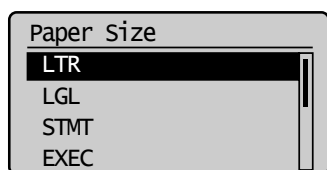

- 4 Press [▲] or [▼] to select a paper type, and then press [OK].

☑ "Paper Requirements" (→P.2-6)

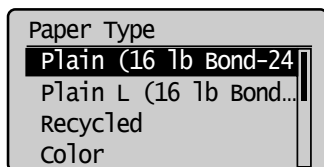

- 5 Press [] (Paper Settings) to close <Paper Settings> screen.

Setting a Custom Paper Size

To use custom paper, you must specify a paper size and type.

Keys to be used for this operation

Paper Settings

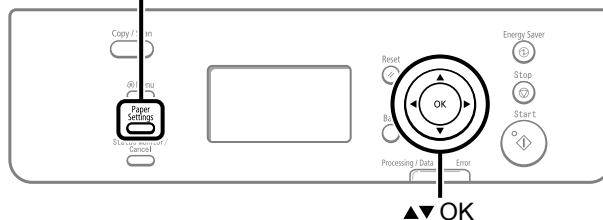

- 1 Press [] (Paper Settings).
- 2 Press [▲] or [▼] to select <MP Tray> or <Drawer 1>, and then press [OK].

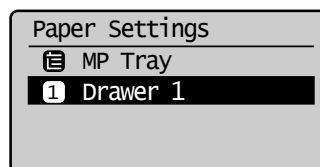

- 3 Press [▲] or [▼] to select <Custom Size>, and then press [OK].

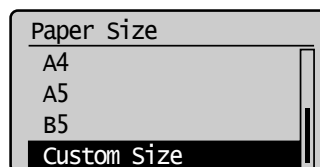

4 Specifies the size of <X> direction and <Y> direction.

(1) Press [▲] or [▼] to select the direction, and then press [OK].

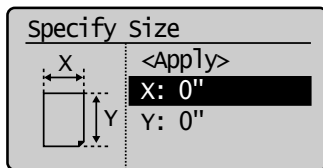

(2) Press [▲] or [▼] to specify the size, and then press [OK].
You can also enter values using the numeric keys.

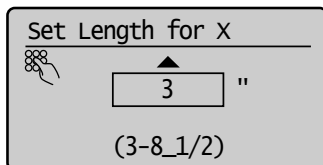

(3) Press [▲] or [▼] to select <Apply>, and then press [OK].

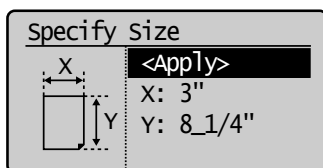

5 Press [▲] or [▼] to select a paper type, and then press [OK].

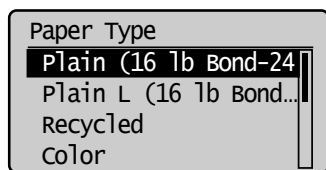

6 Press [] (Paper Settings) to close <Paper Settings> screen.

Selecting Print Side

You can specify whether to match the sides to be printed for 2-sided printing and 1-sided printing. Depending on the setting for this item, the side to be printed changes. When using previously printed paper, read "Paper Loading Orientation" (→P.2-13) thoroughly to load the paper in the proper orientation.

When setting this item to <Print Speed Priority> (the default setting)

Because the sides to be printed for 2-sided printing and 1-sided printing are different, the printing sides do not match.

- * When using previously printed paper, you need to switch the sides of loaded paper between 2-sided printing and 1-sided printing.

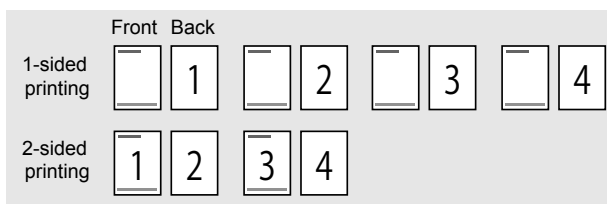

Specify the setting in the following cases.

- When not using previously printed paper
- When performing only 1-sided printing on previously printed paper

When setting this item to <Print Side Priority>

The sides to be printed for 2-sided printing and 1-sided printing match.

- * Even when using previously printed paper, you do not need to switch the sides of loaded paper between 2-sided printing and 1-sided printing.

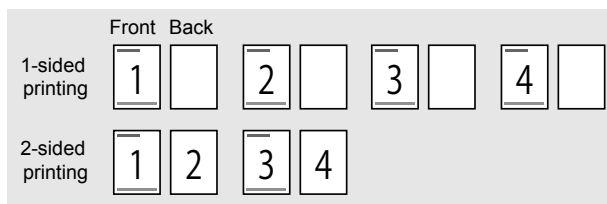

Specify the setting in the following case.

- When performing 2-sided printing and 1-sided printing on previously printed paper

Keys to be used for this operation

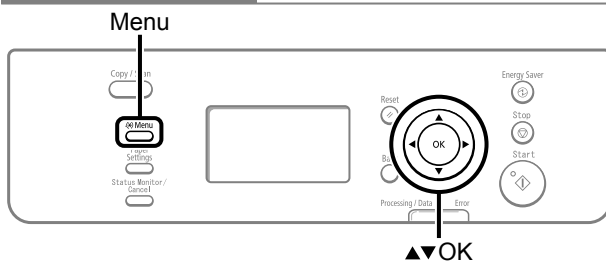

1 Press [] (Menu).

2 Press [▲] or [▼] to select <Preferences>, and then press [OK].

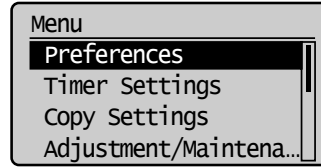

3 Press [▲] or [▼] to select <Paper Feed Method Switch>, and then press [OK].

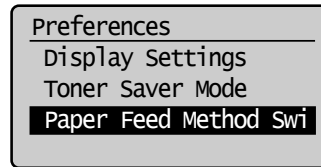

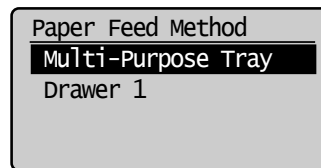

4 Press [▲] or [▼] to select a paper source, and then press [OK].

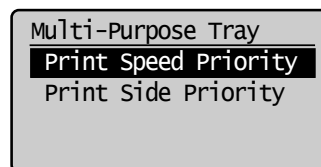

5 Press [▲] or [▼] to select <Print Speed Priority> or <Print Side Priority>, and then press [OK].

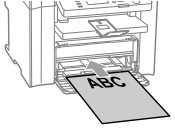
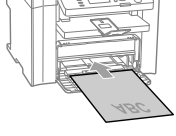
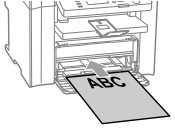
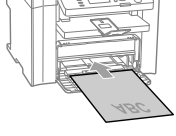
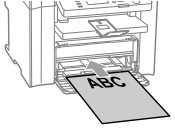
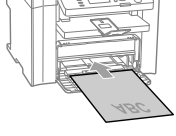
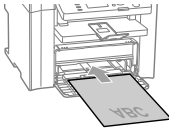

<Print Speed Priority>	<p>When specifying <Print Speed Priority>, load paper as follows.</p> <p>(➡: Feeding direction)</p> <p>* For details on the procedure for loading paper when printing pages of the landscape layout, see "Paper Loading Orientation" (→P.2-13).</p> <table border="1" style="width: 100%; border-collapse: collapse;"> <thead> <tr> <th style="width: 50%; padding: 5px;">When performing 1-sided printing</th> <th style="width: 50%; padding: 5px;">When performing 2-sided printing</th> </tr> </thead> <tbody> <tr> <td style="padding: 5px;">Load paper with the printed side face up.</td> <td style="padding: 5px;">Load paper with the front side (first page) face down.</td> </tr> <tr> <td style="text-align: center; padding: 5px;"></td> <td style="text-align: center; padding: 5px;"></td> </tr> </tbody> </table>	When performing 1-sided printing	When performing 2-sided printing	Load paper with the printed side face up.	Load paper with the front side (first page) face down.		
When performing 1-sided printing	When performing 2-sided printing						
Load paper with the printed side face up.	Load paper with the front side (first page) face down.						
							
<Print Side Priority>	<p>When specifying <Print Side Priority>, load paper as follows.</p> <p>(➡: Feeding direction)</p> <p>* For details on the procedure for loading paper when printing pages of the landscape layout, see "Paper Loading Orientation" (→P.2-13).</p> <div style="border: 1px solid black; padding: 10px; margin: 10px 0;"> <p>The procedure for loading paper is the same for 2-sided printing and 1-sided printing.</p> <ul style="list-style-type: none"> • When performing 1-sided printing, load paper with the printed side face down. • When performing 2-sided printing, load paper with the front side (first page) face down. </div> <div style="text-align: center; margin-top: 10px;"></div>						

6 Press [] (Menu) to close the menu screen.

Copying

This category describes the copying features.

Basic Copying Method **3-2**

Checking and Canceling Copy Jobs	3-3
Canceling using the Stop Key	3-3
Checking and Canceling using the Status Monitor/Cancel Key	3-3

Copy Settings **3-4**

Adjusting the Density	3-4
Selecting Image Quality (Copy)	3-4
2-Sided Copying	3-5
Enlarging/Reducing Copies	3-6
Multiple Documents onto One Sheet (N on 1)	3-6
Collating Copies	3-7
Emphasize the Outline of an Image (Sharpness)	3-7

Copying an ID Card **3-8**

Changing the Default Values **3-9**

Basic Copying Method

This section describes the basic procedure for copying.

1 Place documents.

- ▶ "Placing Documents" (→P.2-4)
- ▶ "Document Requirements" (→P.2-2)

* A maximum of 50 pages can be loaded into the feeder.

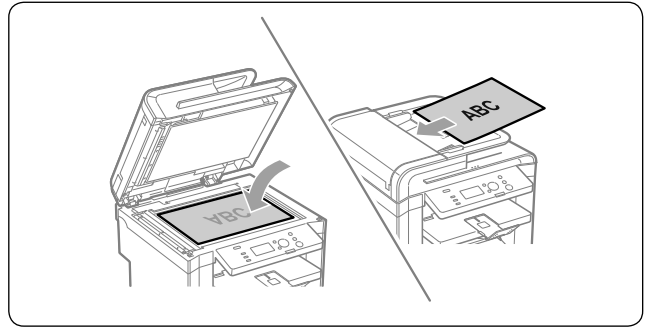

2 Press [Copy / Scan]. (Copy/Scan) until the copy mode screen appears.

4 Enter the desired copy quantity.

- (1) Press [▲] or [▼] to select <No. of Copies>, and then press [OK].
- (2) Press [▲] or [▼] to enter the desired copy quantity (1 to 99), and then press [OK].

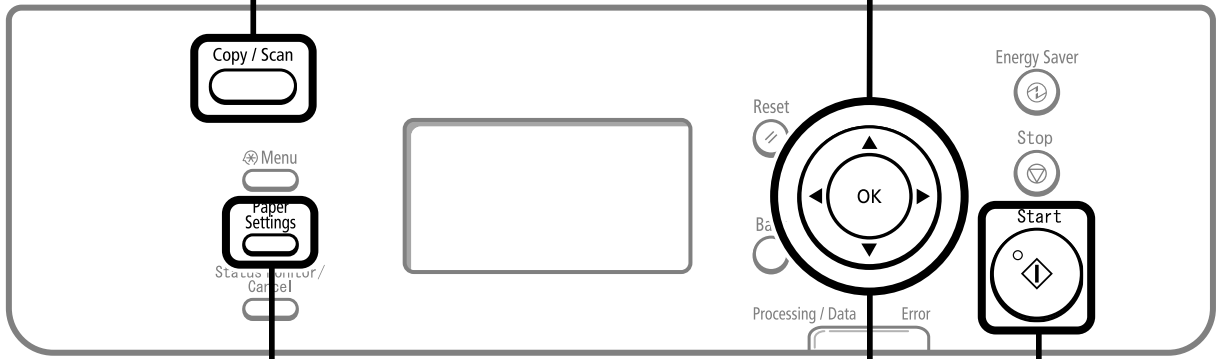

3 Specify the copy settings as needed.

You can specify up to 7 items.
(for details, see P.3-3 to P.3-6.)

- | | |
|---------------------------|-------------------------|
| 1 Density | 5 Reduced layout |
| 2 Image quality | 6 Collating |
| 3 2-Sided | 7 Sharpness |
| 4 Enlarged/reduced | |

5 Press [Start].

The settings that are specified here apply only to copy operation which you are currently performing. To apply the valid settings for all copy operations, see "Changing the Default Values" (→P.3-9).

Checking and Canceling Copy Jobs

You can check detailed information about copy jobs. Also, you can cancel copy jobs while the jobs are in process.

NOTE

If the processing/Data indicator on the operation panel is:

Turned on/blinking	A job is being processed.
Turned off	No jobs are in the memory.

Canceling using the Stop Key

1 Press [] (Stop).

* If only one job is processing or waiting, you can stop the job by pressing [] (Stop) twice.

2 When multiple jobs are being processed, press [▲] or [▼] to select a job to be canceled, and then press [OK].

3 When <Cancel?> appears, press [▲] or [▼] to select <Yes>, and then press [OK].

You can cancel the print job also by pressing [] (Stop).
The copy job is canceled.

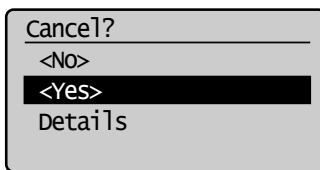

* To check the job before canceling, press [▲] or [▼] to select <Details>, and then press [OK].

Checking and Canceling using the Status Monitor/Cancel Key

1 Press [] (Status Monitor/Cancel).

2 Press [▲] or [▼] to select <Copy Job Status>, and then press [OK].

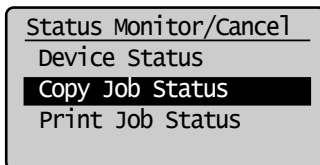

The detailed information is displayed.

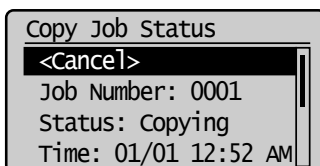

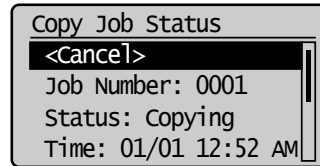

For canceling

(1) Press [▲] or [▼] to select <Cancel>, and then press [OK].

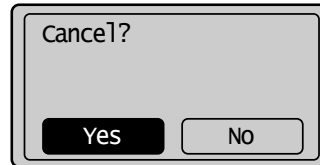

(2) Press [◀] or [▶] to select <Yes>, and then press [OK].
The copy job is canceled.



(3) Press [] (Status Monitor/Cancel) to close the screen.

For checking only

Press [] (Status Monitor/Cancel) to close the screen.

Copy Settings

1 Adjusting the Density

Copy mode screen

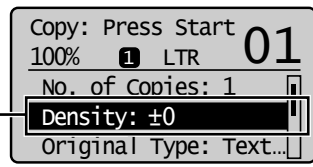

Press [▲] or [▼] to select <Density>



Setting screen

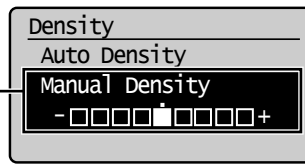

Press [◀] or [▶] to adjust the density → [OK]

[◀]	Makes the copy density lighter.
[▶]	Makes the copy density darker.

- * Select <Auto Density> to copy with the density that is suitable for the document. If other than <Text> is set as <Original Type>, <Original Type> will be changed to <Text> when you select <Auto Density>.
- * You can adjust <Manual Density> by pressing [◀] or [▶], when either of <Auto Density> or <Manual Density> is selected.

2 Selecting Image Quality (Copy)

Copy mode screen

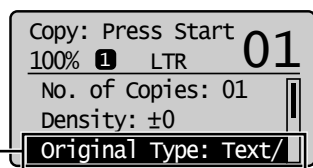

Press [▲] or [▼] to select <Original Type>



Setting screen

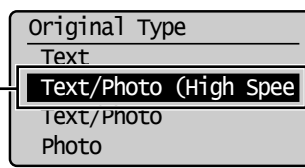

Press [▲] or [▼] to select the appropriate settings for the document → [OK]

<Text>	This setting is suitable for documents that contain text without photos or illustrations.
<Text/Photo (High Speed)>	This setting is suitable for documents that contain text and photos. This setting scans the document at a low resolution. This setting scans the document at a low resolution.
<Text/Photo>	This setting is suitable for documents that contain text and photos.
<Photo>	This setting is suitable for the documents that contain photos printed in a magazine.

- * If <Density> is set to <Auto Density>, <Density> will be changed to <Manual Density> when you select <Text/Photo (High Speed)>, <Text/Photo>, <Photo>.

Copy Settings

3 2-Sided Copying

Copy mode screen

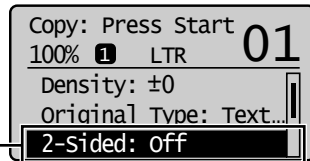

Press [▲] or [▼] to select <2-Sided>

● 1-sided documents → 2-sided copies

Setting screen

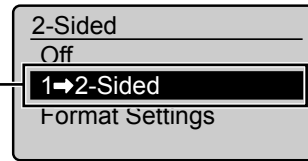

Press [▲] or [▼] to select <1→2-Sided> → [OK]

● 2-sided documents → 2-sided copies

Setting screen

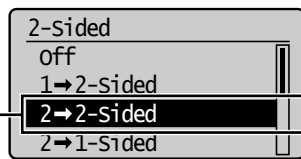

Press [▲] or [▼] to select <2→2-Sided> → [OK]

● 2-sided documents → 1-Sided copies

Setting screen

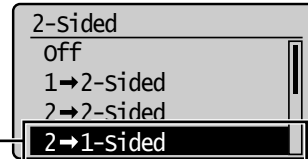

Press [▲] or [▼] to select <2→1-Sided> → [OK]

If you want to specify 2-Sided copying format

(1) Press [▲] or [▼] to select <Format Settings> → [OK]

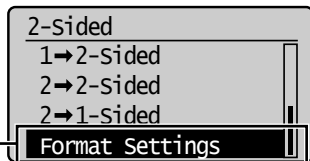

(2) Press [▲] or [▼] to select <1 → 2-Sided> → [OK]

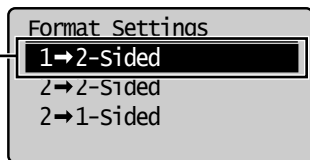

(3) Press [▲] or [▼] to select the orientation of the document → [OK]

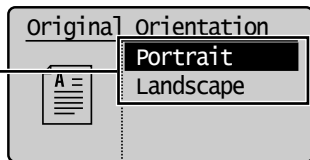

(4) Press [▲] or [▼] to select the original format → [OK]

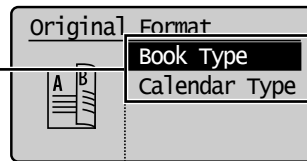

(5) Press [▲] or [▼] to select the finishing format → [OK]

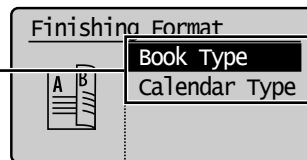

If you place documents on the platen glass

(1) Place the next document, and the press [Start] (Start).

* Repeat the procedure until all documents are scanned.



(2) Press [▲] or [▼] to select <Start Copying>, and then press [OK].

Copy Settings

4 Enlarging/Reducing Copies

Copy mode screen

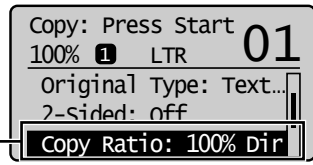

Press [▲] or [▼] to select <Copy Ratio>

Setting screen

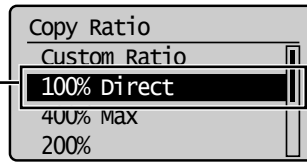

Press [▲] or [▼] to select the copy ratio → [OK]

Load paper of the output size (→P.2-9)

Register the output paper size (→P.2-14)

For the preset zoom, you can select from the following setting values.

- 100% Direct
- 400% Max
- 200%
- 129% STMT → LTR
- 78% LGL → LTR
- 64% LTR → STMT
- 50%
- 25% Min

For custom ratio

- (1) Press [▲] or [▼] to select <Custom Ratio> → [OK]
- (2) Press [▲] or [▼] to specify the ratio → [OK]

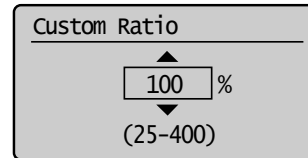
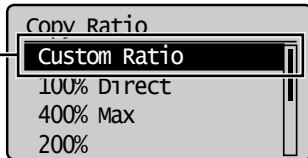

5 Multiple Documents onto One Sheet (N on 1)

Copy mode screen

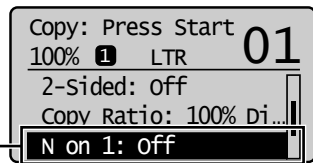

Press [▲] or [▼] to select <N on 1>

Setting screen

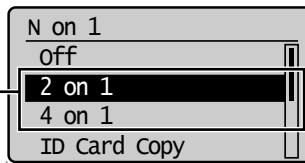

Press [▲] or [▼] to select <2 on 1> or <4 on 1>

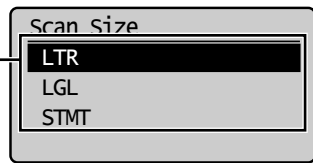

Press [▲] or [▼] to select the size of the original document → [OK]

About margins among documents

When you copy in an N on 1 layout, margins are created among the reduced documents.

<2 on 1>	Reduce two-page documents to fit on one sheet of paper.
<4 on 1>	Reduce four-page documents to fit on one sheet of paper.

When specifying the layout

- (1) Press [▲] or [▼] select <Select Layout> → [OK]

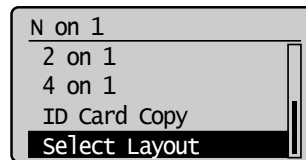

- (2) Press [▲] or [▼] select the layout → [OK]

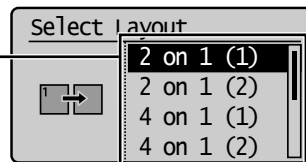

Copy Settings

6 Collating Copies

Copy mode screen

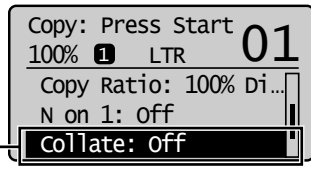

Press [▲] or [▼] to select <Collate>

Setting screen

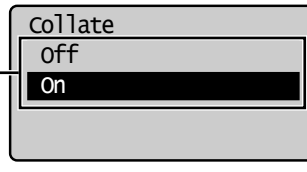

Press [▲] or [▼] to select <On> → [OK]

<Off>	<p>Printouts of a complete job are grouped. For example, if you are copying three copies of a three-page document, printouts of a complete job are grouped and arranged in this page order: "1, 1, 1," "2, 2, 2," "3, 3, 3".</p>	
<On>	<p>Printouts of a complete job are collated. For example, if you are printing three copies of a three-page document, printouts of a complete job are grouped and arranged in this page order: "1, 2, 3," "1, 2, 3," "1, 2, 3".</p>	

7 Emphasize the Outline of an Image (Sharpness)

Copy mode screen

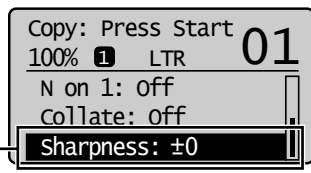

Press [▲] or [▼] to select <Sharpness>

Setting screen

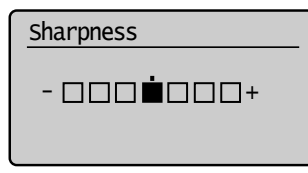

Press [◀] or [▶] to adjust the sharpness → [OK]

[◀]	<p>Reduces distorted pattern (moire). It is appropriate for documents that contain halftone such as printed photos.</p>
[▶]	<p>Raise the sharpness and emphasize the outline of text or lines. It is appropriate for documents which are blueprints or thinly penciled.</p>

Copying an ID Card

You can make a copy of a 2-sided card onto one side of a paper.

Keys to be used for this operation

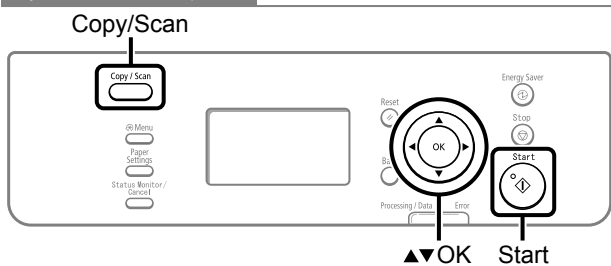

1 Place a card on the platen glass, and then close the feeder.

Place the card with a 1/4" (5 mm) space created from the left edge of the platen glass.

Additionally, align the center of the card with the arrow mark.

If you want to arrange the cards horizontally

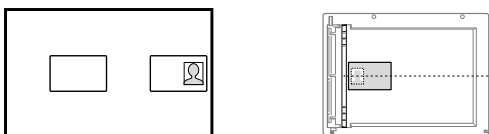

If you want to arrange the cards vertically

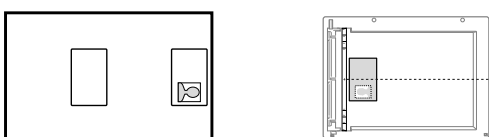

2 Press [].

3 Press [▲] or [▼] to select <N on 1>, and then press [OK].

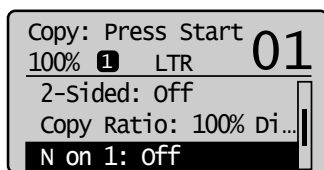

4 Press [▲] or [▼] to select <ID Card Copy>, and then press [OK].

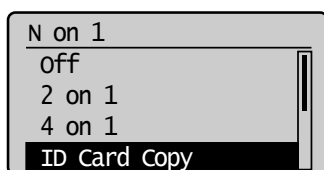

5 Press [] (Start).

After scanning the document completely, proceed to the next step.

6 Turn and place the card.

Place the card with a 1/4" (5 mm) space created from the left edge of the platen glass.

Additionally, align the center of the card with the arrow mark.

If you want to arrange the cards horizontally

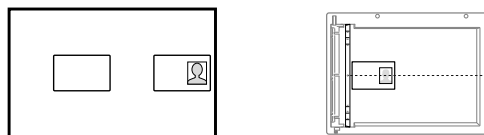

If you want to arrange the cards vertically

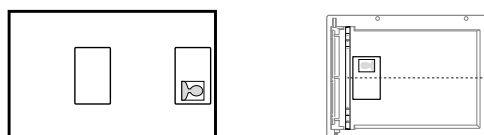

7 Press [] (Start).



NOTE

Placing a document (card)

Place a card on the left half of the platen glass.

Copy ratio

The copy ratio will automatically be set to <100%>.

Usable paper size

A size larger than A4 or Letter

Unavailable functions in combination

You cannot use an ID card copy together with the following functions.

- 2 on 1/4 on 1
- Collating
- 2-Sided
- Copy ratio

Changing the Default Values

The default values of the copy are the function which is applied when [] (Reset) is pressed or the power is turned ON. You can change the default values to suit your needs. You can register the following types of settings as the default values.

- Quantity
- Density
- Original type
- 2-Sided
- Copy ratio
- N on 1
- Collating
- Sharpness

Keys to be used for this operation

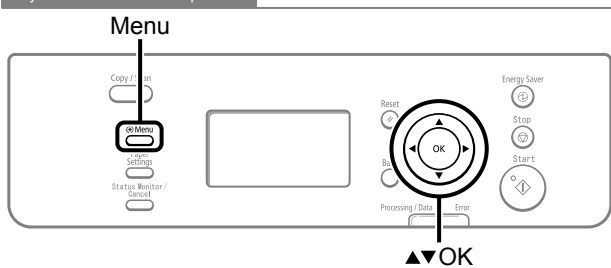

1 Press [] (Menu).

2 Press [▲] or [▼] to select <Copy Settings>, and then press [OK].

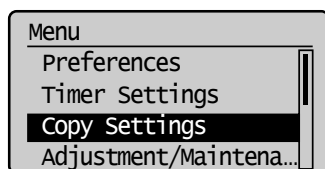

3 Press [▲] or [▼] to select <Change Defaults>, and then press [OK].

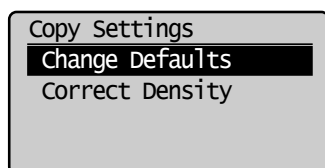

4 Press [▲] or [▼] to select a setting item, and then press [OK].

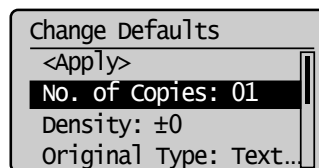

For details on the settings, see the following items.

- ▶ "Adjusting the Density" (→P.3-4)
- ▶ "Selecting Image Quality (Copy)" (→P.3-4)
- ▶ "2-Sided Copying" (→P.3-5)
- ▶ "Enlarging/Reducing Copies" (→P.3-6)
- ▶ "Multiple Documents onto One Sheet (N on 1)" (→P.3-6)
- ▶ "Collating Copies" (→P.3-7)
- ▶ "Emphasize the Outline of an Image (Sharpness)" (→P.3-7)

5 After you are finished press [▲] or [▼] to select <Apply>, and then press [OK].

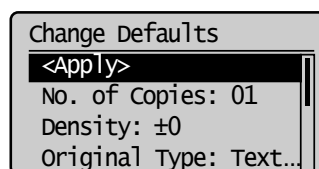

6 Press [] (Menu) to close the menu screen.

Printing from a Computer

This category describes how to print from computers.

* If you are a Macintosh user, see the following.

- To install the Print Driver
→ Starter Guide or Print Driver Guide
- To view how to use each function
→ Print Driver's Help

To view how to display the Print Driver Guide or Print Driver's Help, see "For Macintosh Users" (→P.9-4).

Installing the Printer Driver	4-2
--------------------------------------	------------

Printing from a Computer	4-3
---------------------------------	------------

Scaling Documents.....	4-3
Printing Multiple Pages on One Sheet.....	4-3
2-sided Printing.....	4-4
Checking and Canceling Print Jobs.....	4-5

● Installing the Printer Driver

The following procedures are required as the preparations for printing.

Step 1	Install the printer driver.	 Starter Guide → 4 Connecting to a Computer and Installing the Drivers
---------------	-----------------------------	--



NOTE

About the printer driver

The printer driver is software required for printing from an application. The printer driver will convert application software's print data to print data for the printer.

The printer driver for this machine has the following features.

- The printer driver for this machine enables you to output print data at an optimum speed by dividing the workload using a computer and the printer.
- As well as providing faster and more stable printing than conventional models, the printer driver for this machine uses less memory to operate.
- In addition to the conversion of print data, the printer driver for this machine is equipped with the functions capable of spooling print data and configuring the print condition, and various types of print finishing can be set such as scaling or gutter adjustment.

Printing from a Computer

Scaling Documents

You can enlarge or reduce documents to match the output paper size.

There are two methods for scaling a document: select the output size of the document to scale it automatically, or specify the scaling value manually.

1 Click [Page Setup].

For instructions on how to display the printer driver screen, see "Printing" or "Configuring the Default Print Settings" in the e-Manual.

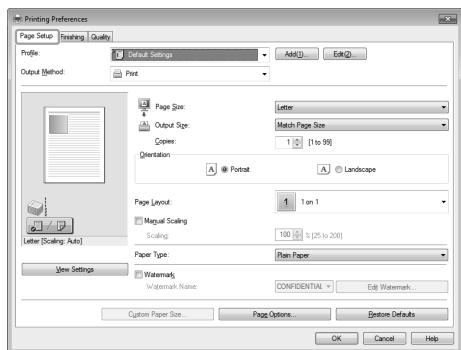

2 Select paper size of the document you created in the application from [Page Size].

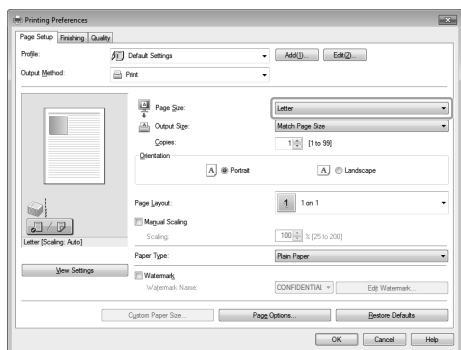

3 Select output size of the document from [Output Size].

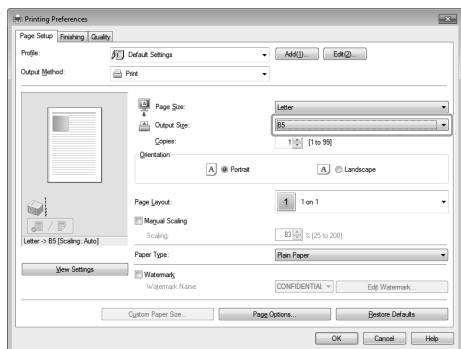

The document is scaled automatically according to the settings made in [Page Size] and [Output Size].

4 If you want to increase or decrease the magnification manually, select [Manual Scaling] → specify the scaling ratio for [Scaling].

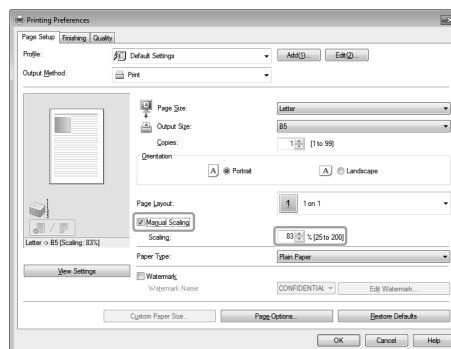

5 Click [OK].



NOTE

- Depending on the printer model you are using, you may not be able to magnify the document to the optimum ratio for the selected page size.
- The display may differ according to the operating system, as well as the type and version of the printer driver.

Printing Multiple Pages on One Sheet

You can reduce and print multiple pages on a single sheet of paper. You can place 2, 4, 6, 8, 9, and 16 pages of documents on a single sheet of paper. Using this feature, you can make materials that are easy to view. Also, this feature helps you to save paper, and save space when storing.

1 Click [Page Setup].

For instructions on how to display the printer driver screen, see "Printing" or "Configuring the Default Print Settings" in the e-Manual.

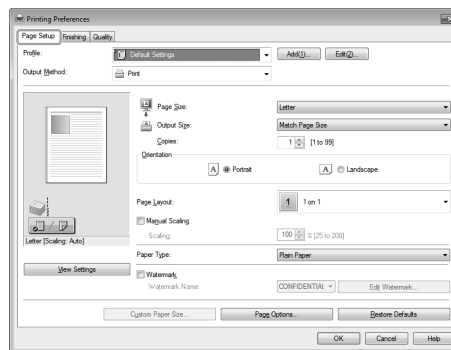

2 Select the page layout from [Page Layout].

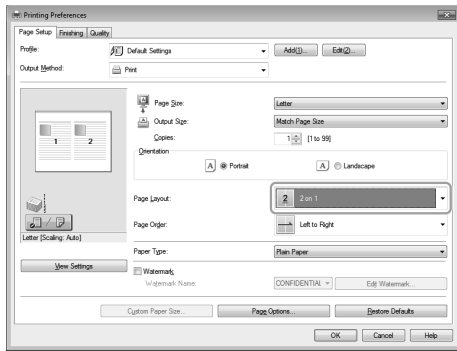

3 Select the page order from [Page Order].

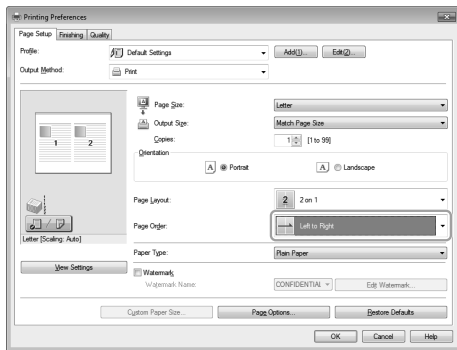

The output image is displayed in the preview area.

4 Click [OK].

NOTE

- You cannot enlarge and reduce manually when using this function.
- Although there may be a function for printing multiple copies depending on the application you are using, do not use it together with this function. If you do, printing may not be executed correctly.
- The display may differ according to the operating system, as well as the type and version of the printer driver.

2-sided Printing

Two-sided printing prints a document on both sides of the paper. You can reduce paper consumption by half.

1 Click [Finishing].

For instructions on how to display the printer driver screen, see "Printing" or "Configuring the Default Print Settings" in the e-Manual.

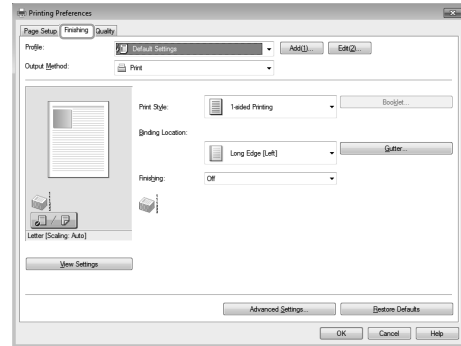

2 Select [2-sided Printing] from [Print Style].

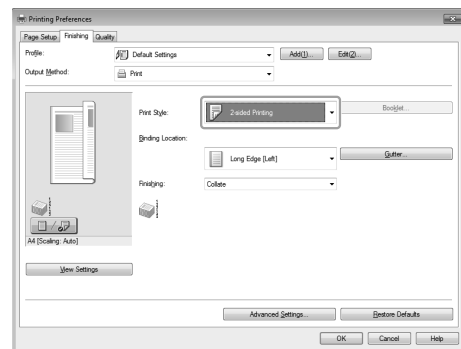

3 Select the binding edge from [Binding Location].

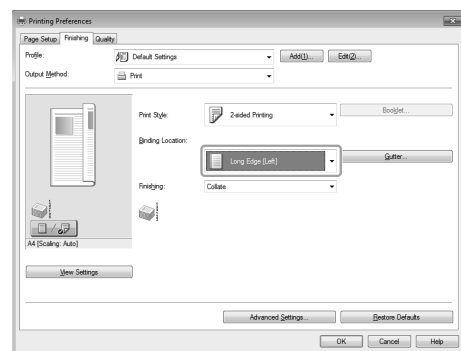

The output image is displayed in the preview area.

4 Click [OK].

NOTE

- The page sizes for which two-sided printing is available differ according to printer model. For details, view the online help.
- The display may differ according to the operating system, as well as the type and version of the printer driver.

Checking and Canceling Print Jobs

You can check detailed information about print jobs in the middle of currently printing or waiting.

NOTE

Document name and user name displayed in the operation panel

Some file name may be displayed incorrectly depending on the type of the file to be printed.

If the Processing/Data Indicator on the operation panel is:

Turned on/blinking	A job is being processed.
Turned off	No jobs are in the memory.

Keys to be used for this operation

Status Monitor/Cancel

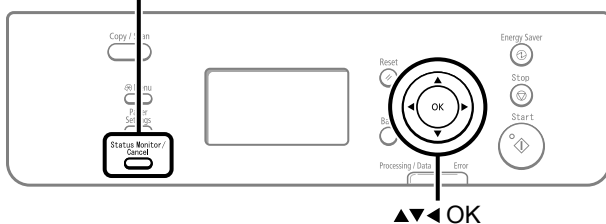

- 1 Press [] (Status Monitor/Cancel).
- 2 Press [▲] or [▼] to select <Print Job Status> and then press [OK].

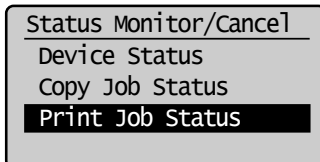

- 3 Press [▲] or [▼] to select a job to be checked or canceled, and then press [OK].

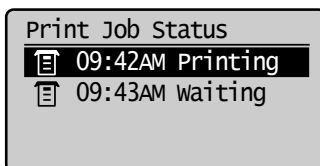

The detailed information is displayed.

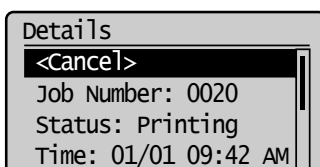

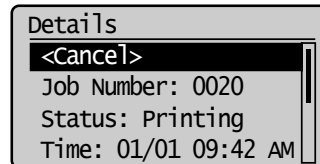

For canceling

- (1) Press [▲] or [▼] to select <Cancel>, and then press [OK].

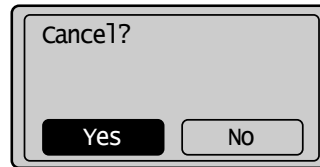

- (2) Press [◀] to select <Yes>, and then press [OK].
The print job is canceled.



- (3) Press [] (Status Monitor/Cancel) to close the screen.

NOTE

Pressing [] (Stop) can also delete the print jobs

You can delete the print jobs also by pressing [] (Stop).

* If only one print job is processing or waiting, you can stop the job by pressing [] (Stop) twice.

For checking only

Press [] (Status Monitor/Cancel) to close the screen.

Using the Scan Functions

The documents scanned by the machine can be stored in a computer.

* If you are a Macintosh user, see the Scanner Driver Guide.

To view how to display the Scanner Driver Guide, see "For Macintosh Users" (→P.9-4).

Basic Operation Methods for Scanning

You can scan a document using the keys on the operation panel.



NOTE

To scan documents by operating a computer

See "Scan" in the e-Manual.

Keys to be used for this operation

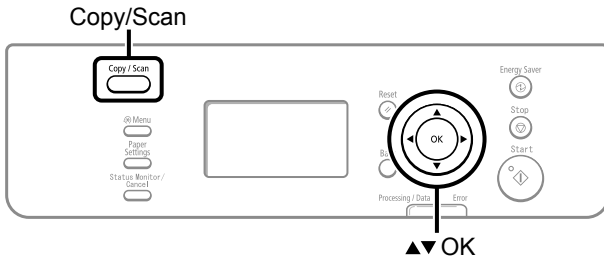

1 Place documents.

- ▶ "Placing Documents" (→P.2-4)
- ▶ "Document Requirements" (→P.2-2)



NOTE

When scanning using the operation panel

You cannot scan multiple documents from the platen glass.

2 Press [] (Copy/Scan) until the scan mode screen appears.

3 Press [▲] or [▼] to select <Computer>, and then press [OK].

Select the scan type.

Computer
Remote Scanner

4 Press [▲] or [▼] to specify the scanner settings and then press [OK].

The scanner settings are specified by default as follows.

	Scan Mode	Resolution	File Type	PDF Settings
Color Scan	Color	300 dpi	PDF	Searchable/High
B&W Scan	Black and White	300 dpi	TIFF	-
Custom 1	Color	300 dpi	JPEG/Exif	-
Custom 2	Color	300 dpi	PDF	Searchable/Standard

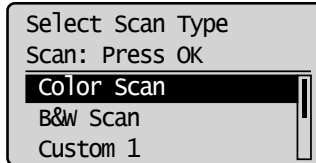

Scanning operation starts, and the scan mode screen reappears after saving the data.



If you cannot scan

You cannot scan when the setting screen of the MF Toolbox is displayed.

Click  to close the setting screen before scanning.

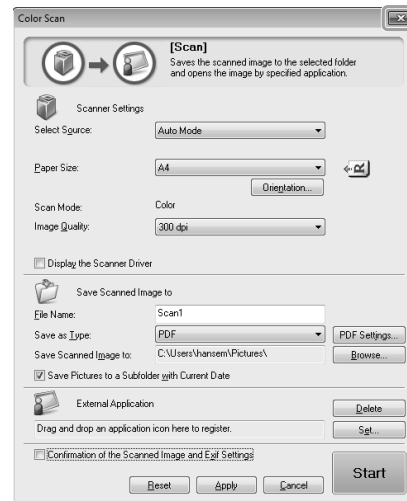

The location to save the scanned images

The folder where the images are saved opens automatically after scanning.

By default, the folder for the date when you scanned the data is created in the [Pictures] folder. (For Windows 2000/XP, the folder is created in the [My Pictures] folder in [My Documents].)



Note

To change the scanner settings

You can change the settings for the location to save, the file format, or the resolution from a computer.

e-Manual → Scan → Using the MF Toolbox

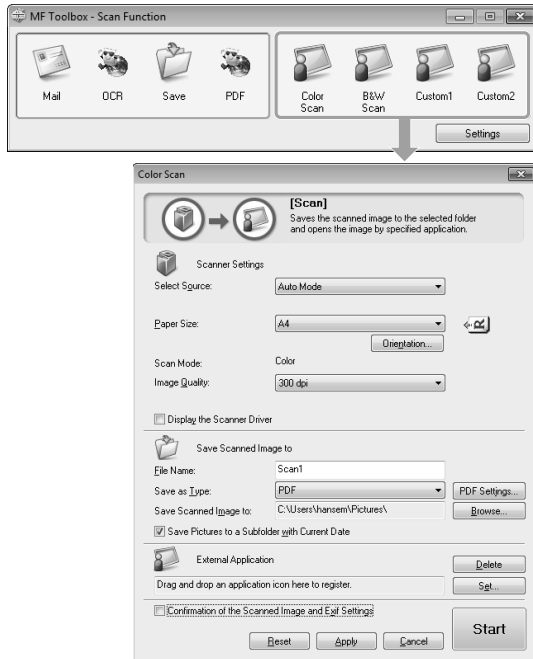

Maintenance

This section describes the maintenance of this machine, replacement of the toner cartridges, and so on.

Cleaning the Machine **6-2**

Cleaning the Exterior	6-2
Cleaning the Interior	6-2
Cleaning the Fixing Unit	6-3
Cleaning the Platen Glass	6-4
Cleaning the Feeder	6-4
Precautions When Cleaning the Machine	6-4

Replacing Toner Cartridges **6-6**

About the Supplied Toner Cartridge	6-6
About Replacement Toner Cartridge	6-6
Handling Toner Cartridge	6-6
Using the Toner Saver Mode	6-7
Before Replacing the Toner Cartridge	6-8
Replacing the Toner Cartridge	6-9
Precautions when Replacing Toner Cartridge	6-11
Purchase Consumables	6-12

Recycling Used Cartridges **6-13**

The Clean Earth Campaign	6-13
U.S.A. PROGRAM	6-13
Packaging	6-13
Shipping	6-14
CANADA PROGRAM-CANADA PROGRAMME	6-15

Transporting the Machine **6-16**

Precautions when Transporting the Machine	6-17
---	------

Cleaning the Machine

Cleaning the Exterior

Clean the exterior of the machine and ventilation slots.

- 1 Turn OFF the power switch and disconnect the power cord.
- 2 Clean the exterior of the machine with a soft, well wrung out cloth dampened with water or mild detergent diluted with water.

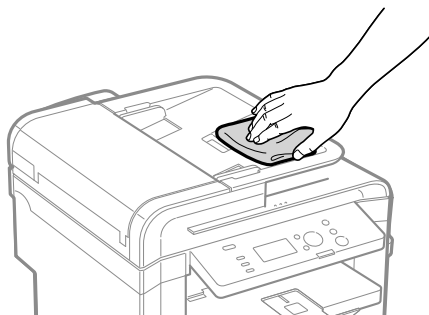

- 3 Wait for the printer to dry completely before reconnecting the power cord, and then turn ON the power.

Cleaning the Interior

Clean the machine's print area periodically to prevent toner powder and paper dust from accumulating inside.

- 1 Turn OFF the power switch and disconnect the power cord.
- 2 Hold the operation panel.

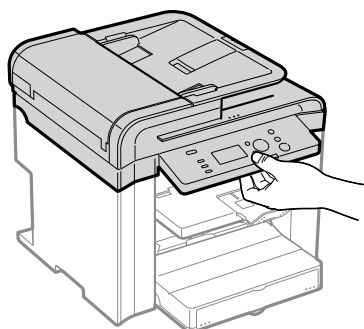

- 3 Lift the scanning platform.

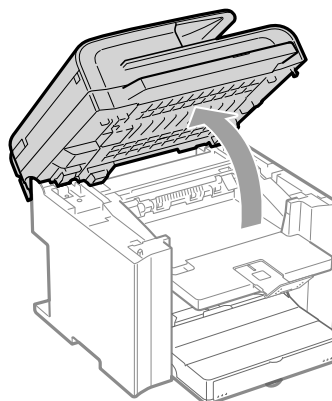

- ?** If you cannot lift the scanning platform

Ensure that the feeder is completely closed.

Do not try to forcefully lift the scanning platform, as this may damage the machine.

* If you set thick documents such as a book, the feeder may not be completely closed. Remove the documents.

- 4 Hold the grip on the left front side of the toner cover.

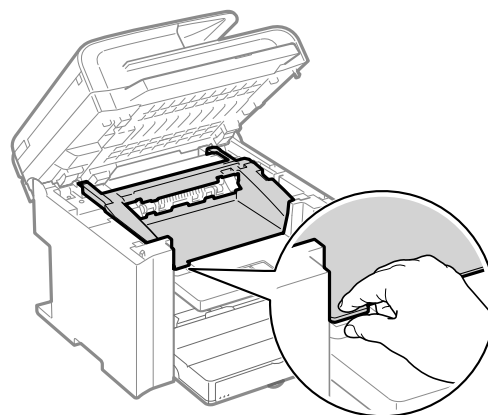

- 5 Open the toner cover.

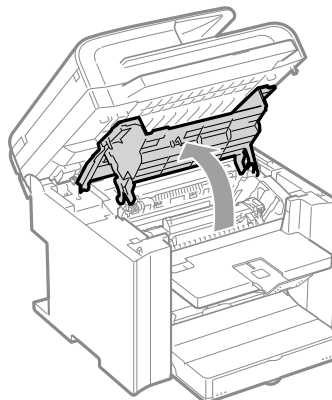

6 Remove the toner cartridge.

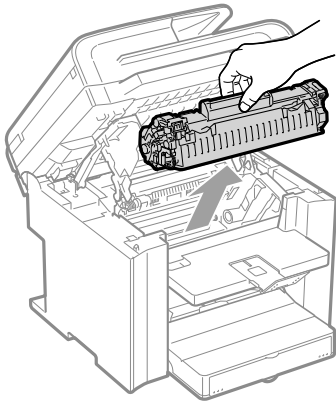

7 Remove any toner or paper debris from interior of the machine, with a clean, soft, dry, and lint-free cloth.

8 Insert the toner cartridge.

Fit the protrusions (A) on each side of the toner cartridge into the guides located on each side of the machine, and then slide the toner cartridge into the machine until the toner cartridge meets the back of the machine.

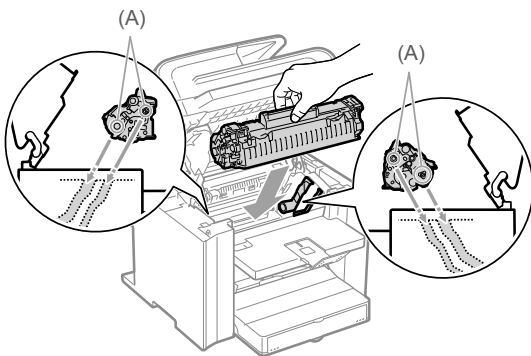

9 Close the toner cover.



If you cannot close the toner cover

Ensure that the toner cartridge is properly set in the machine. Do not try to forcefully close the toner cover, as this may damage the machine.

10 Lower the scanning platform.

11 Connect the power cord and turn ON the power switch.

Cleaning the Fixing Unit

In the following cases, the fixing unit may be dirty. Clean the fixing unit.

- When black streaks appear on the printed paper
- When a toner cartridge is replaced

Keys to be used for this operation

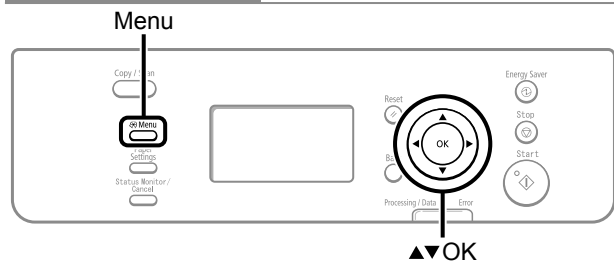

- 1 Press [] (Menu).
- 2 Press [▲] or [▼] to select <Adjustment/Maintenance>, and then press [OK].

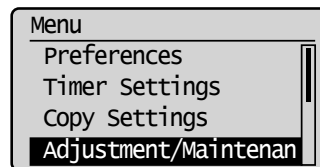

- 3 Press [▲] or [▼] to select <Clean Fixing Unit>, and then press [OK].

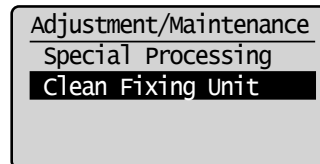

- 4 Load Letter size plain paper in the multi-purpose tray, and then press [OK].

The cleaning process will start. Cleaning takes approximately 90 seconds.

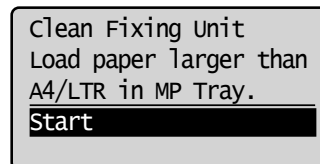

* It is recommended that you use plain paper to clean the fixing unit.



If cleaning does not begin

When there are jobs stored in memory, this function is not available.

- 5 Press [] (Menu) to close the menu screen.

Cleaning the Platen Glass

Follow this procedure to clean the platen glass and under surface of the feeder.

- 1** Turn OFF the power switch and disconnect the power cord.
- 2** Open the feeder.

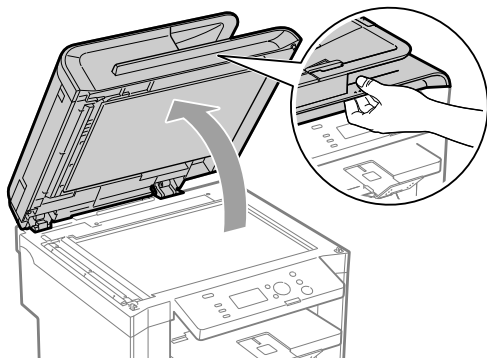

- 3** Clean the platen glass and the under surface of the feeder.

- (1) Clean the areas with a cloth dampened with water.
- (2) Wipe the areas with a soft, dry cloth.

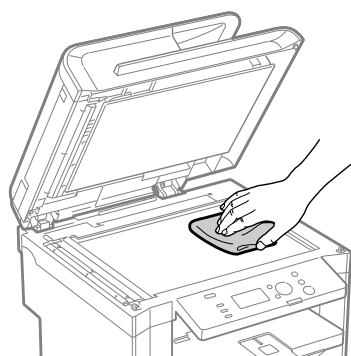

- 4** Close the feeder.
- 5** Connect the power cord and turn ON the power switch.

Cleaning the Feeder

If your documents have black streaks or appear dirty after scanning using the feeder, the roller inside the feeder may be dirty. Clean the feeder scanning area and roller.

- 1** Turn OFF the power switch and disconnect the power cord.
- 2** Open the feeder cover.

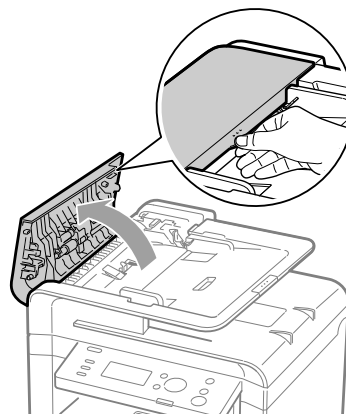

- 3** Clean the rollers (A) inside the feeder with a well wrung out cloth dampened with water, and then wipe the area with a soft, dry cloth.

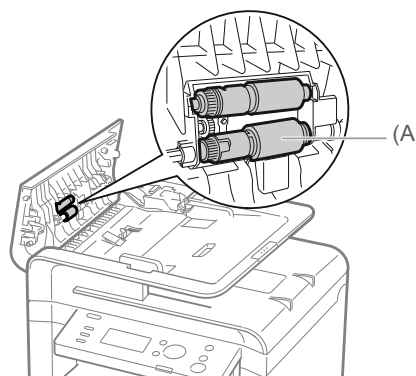

- 4** Close the feeder cover.
- 5** Connect the power cord and turn ON the power switch.

Precautions When Cleaning the Machine

Before cleaning the machine, check the following.

- Ensure no jobs are stored in memory, then turn OFF the power switch and disconnect the power cord.
- Use a soft cloth to avoid scratching the components.
- Do not use tissue paper, paper towels, or similar materials for cleaning. They can stick to the components or generate static charges.

CAUTION

Precautions when cleaning the feeder

Do not dampen the cloth too much, as this may tear the document or damage the machine.

Precautions when closing the feeder

Be careful not to get your fingers caught.

Do not touch the fixing unit (A).

Touching the fixing unit (A) may cause burns as it becomes very hot during use.

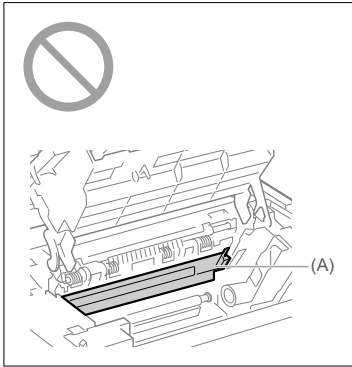

Precautions if you get toner on your hands or clothing

If toner gets on your hands or clothing, wash them immediately with cold water.

Washing with warm water sets the toner, making it impossible to remove the toner stains.

IMPORTANT

Do not touch the transfer roller (A).

Touching the transfer roller (A) may damage the machine.

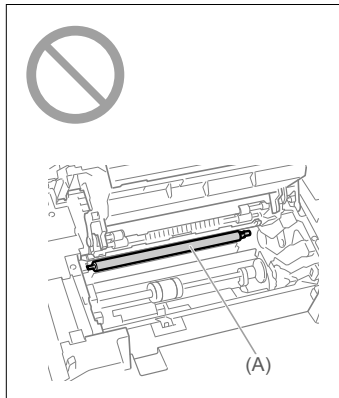

NOTE

If there is data waiting to be printed

The data is deleted when you turn OFF the power switch.

Replacing Toner Cartridges

Toner cartridges are consumable products. When the toner has almost or completely run out in the middle of operating this machine, a message appears in the display, or the symptoms described below appears. Follow a proper resolution depending on the message or symptom.



IMPORTANT

About toner cartridges

For details on the toner cartridge yields and the procedures for handling toner cartridges and checking the toner level, see the following.

- ▶ About the Supplied Toner Cartridge (→P.6-6)
- ▶ About Replacement Toner Cartridge (→P.6-6)
- ▶ Handling Toner Cartridge (→P.6-6)
- ▶ Using the Toner Saver Mode (→P.6-7)
- ▶ Purchase Consumables (→P.6-12)

* The yields of the toner cartridges included in this machine differ from those of replacement toner cartridges.

If the toner almost runs out, white streaks appear on the printouts or some parts are faded.

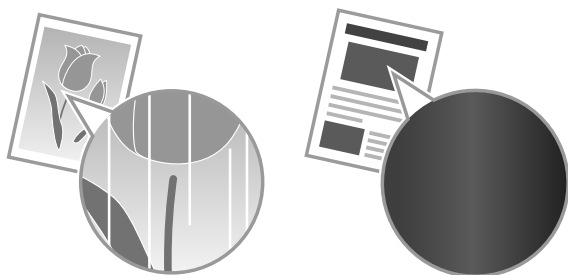

* No message appears on the display even if the toner almost runs out. Replace the toner cartridge when white streaks appear on the printouts or some parts of the printout are faded.

If the above symptoms appear



Follow the procedure in the section below before replacing the toner cartridge. You may print for some time, until the toner completely runs out.

- ▶ "Before Replacing the Toner Cartridge" (→P.6-8)

If print result is not improved



If white streaks or faded parts continue to appear after following the procedure in the section above, replace the toner cartridge.

- ▶ "Replacing the Toner Cartridge" (→P.6-9)

About the Supplied Toner Cartridge

The average yield of the included toner cartridge is as follows.

Canon Cartridge 128 Starter	Average yield ^{*1} : 1,000 sheets
------------------------------------	--

^{*1} The average yield is on the basis of "ISO/IEC 19752"^{*2} when printing A4 size paper with the default print density setting.

^{*2} "ISO/IEC 19752" is the global standard related to "Method for the determination of toner cartridge yield for monochromatic electrophotographic printers and multi-function devices that contain printer components" issued by ISO (International Organization for Standardization).

The average yield of the replacement toner cartridge is different from which of the supplied toner cartridge.

About Replacement Toner Cartridge

Purchase the toner cartridge at your local authorized Canon dealer.

Replace the toner cartridge according to the description in the following charts. However, you may need to replace the toner cartridge earlier than the described life time depending on installation environment of the machine, the printing paper size, or the document type.

Toner cartridge	Target for replacing toner cartridge
Canon Cartridge 128	Average yield ^{*1} : 2,100 sheets

^{*1} The average yield is on the basis of "ISO/IEC 19752"^{*2} when printing A4 size paper with the default print density setting.

^{*2} "ISO/IEC 19752" is the global standard related to "Method for the determination of toner cartridge yield for monochromatic electrophotographic printers and multi-function devices that contain printer components" issued by ISO (International Organization for Standardization).



IMPORTANT

About Replacement Toner Cartridge

For optimum print quality, replacing the toner cartridge with Canon genuine ones is recommended.

Model name	Supported Canon genuine toner cartridge
D550	Canon Cartridge 128

Handling Toner Cartridge

Note the following when handling the toner cartridge.

CAUTION

Do not place the toner cartridge in fire.

This may cause toner remaining inside the cartridge to ignite and result in burns.

If toner leaks from the toner cartridge

Be careful not to inhale the toner or allow it to come into direct contact with your skin. If the toner comes into contact with your skin, wash with soap. If the skin becomes irritated or you inhale the toner, consult a physician immediately.

When removing a toner cartridge

Ensure to remove it carefully. If not removed with care, the toner powder may scatter and come in contact with your eyes and mouth. If toner gets into your eyes or mouth, wash them immediately with cold water and consult a physician.

Keep the toner cartridge away from small children.

If the toner or other parts are ingested, consult a physician immediately.

Do not disassemble the toner cartridge.

The toner may scatter and get into your eyes or mouth. If toner gets into your eyes or mouth, wash them immediately with cold water and consult a physician.

IMPORTANT

Handling toner cartridge

- Keep the toner cartridge away from computer screens, disk drives, and floppy disks. They may be damaged by magnet which is inside of the toner cartridge.
- Avoid locations subject to high temperature, high humidity, or rapid changes in temperature.
- Do not expose the toner cartridge to direct sunlight or bright light for more than five minutes.
- Store the toner cartridge in its protective bag. Do not open the bag until you are ready to install the toner cartridge in the machine.
- Keep the protective bag for the toner cartridge. They are required when transporting the machine such as during relocation.
- Do not store the toner cartridge in a salty atmosphere or where there are corrosive gases such as from aerosol sprays.
- Do not remove the toner cartridge from the machine unnecessarily.
- Print quality may deteriorate if the drum surface is exposed to light or is damaged.
- Always hold the toner cartridge by its handle to avoid touching the drum.
- Do not place the toner cartridge in an upright or an upside down position. If the toner is kept upright or upside down, the toner will solidify and may not return to its original condition even if it is shaken.
- When disposing of a used toner cartridge, place the toner container into its protective bag to prevent the toner from scattering, and then dispose of the toner cartridge according to local regulations.

Be careful of counterfeit toner cartridges.

Please be aware that there are counterfeit Canon toner cartridges in the marketplace.

Use of counterfeit toner cartridges may result in poor print quality or machine performance.

Canon is not responsible for any malfunction, accident or damage caused by the use of counterfeit toner cartridge.

For more information, see <http://www.canon.com/counterfeit>.

Using the Toner Saver Mode

Set whether or not to conserve toner when copying.



NOTE

If you want to conserve toner when printing

Set to use [Toner Save] on the [Quality] tab of the printer driver.

☞ e-Manual → Print → Printing Functions → [Quality] Sheet

Keys to be used for this operation

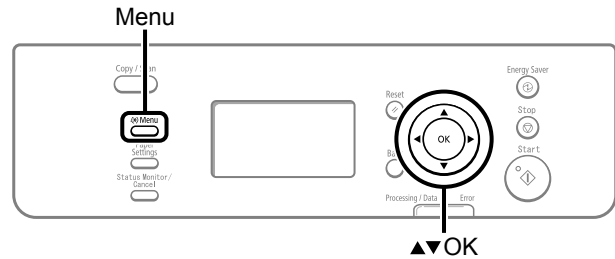

- 1 Press [] (Menu).
- 2 Press [▲] or [▼] to select <Preferences>, and then press [OK].

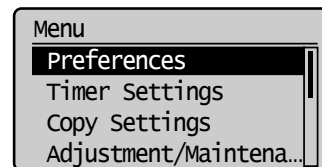

- 3 Press [▲] or [▼] to select <Toner Saver Mode>, and then press [OK].

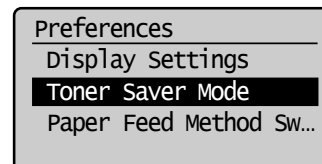

- 4 Press [▲] or [▼] to apply the toner saver mode to an operation, and then press [OK].

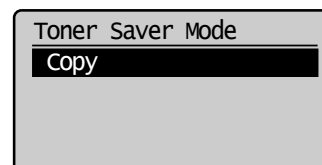

- 5** Press [▲] or [▼] to select <Off> or <On>, and then press [OK].

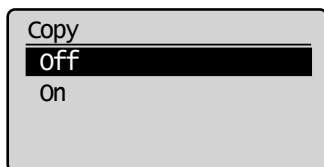

<Off>	Do not use the toner saver mode.
<On>	Use the toner saver mode.



NOTE

When the <Toner Saver Mode> is set to <On>

You may conserve toner, however, the output may be less clear and thin lines or light colors may be printed unclearly.

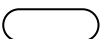
- 6** Press [] (Menu) to return to standby mode.

Before Replacing the Toner Cartridge

Before replacing the toner cartridge, see "Replacing the Toner Cartridge" (→P.6-9)

If the toner almost runs out, follow the procedure below before replacing the toner cartridge. You may print for some time, until the toner is completely run out.

- 1** Hold the operation panel.

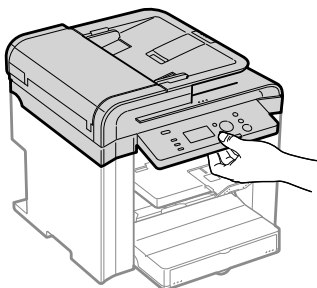

- 2** Lift the scanning platform.

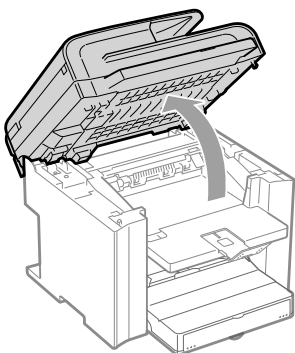

If you cannot lift the scanning platform

Ensure that the feeder is completely closed.

Do not try to forcefully lift the scanning platform, as this may damage the machine.

* If you set thick documents such as a book, the feeder may not be completely closed. Remove the documents.

- 3** Hold the grip on the left front side of the toner cover.

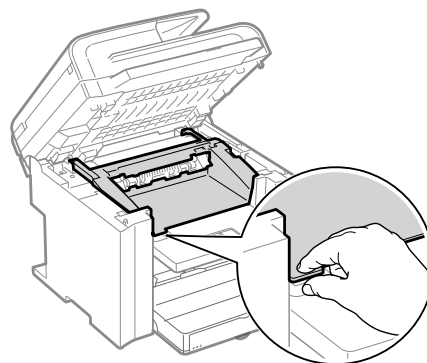

- 4** Open the toner cover.

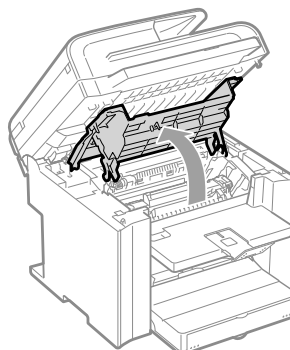

- 5** Remove the toner cartridge.

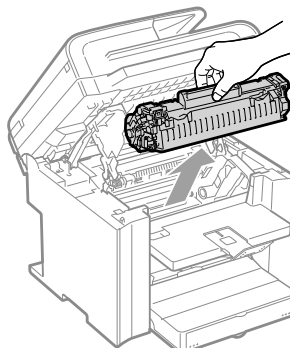

- 6** Gently shake the toner cartridge five or six times to evenly distribute the toner.

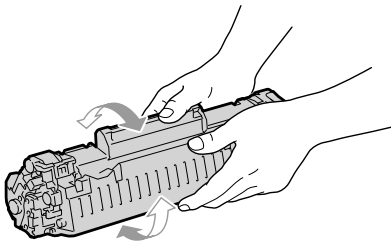

- 7** Insert the toner cartridge.

Fit the protrusions (A) on each side of the toner cartridge into the guides located on each side of the machine, and then slide the toner cartridge into the machine until the toner cartridge meets the back of the machine.

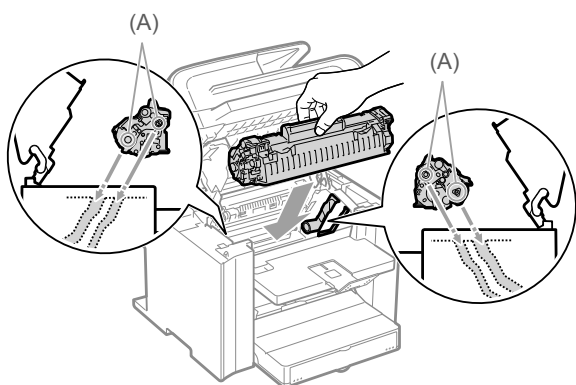

- 8** Close the toner cover.

? **If you cannot close the toner cover**
Ensure that the toner cartridge is properly set in the machine.
Do not try to forcefully close the toner cover, as this may damage the machine.

- 9** Lower the scanning platform.

Replacing the Toner Cartridge

Before replacing toner cartridges, see "Precautions when Replacing Toner Cartridge" (→P.6-11)

- 1** Hold the operation panel.

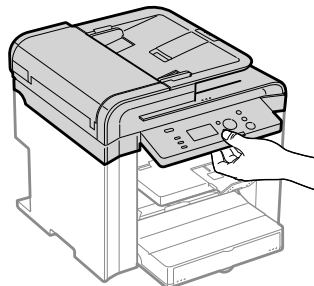

- 2** Lift the scanning platform.

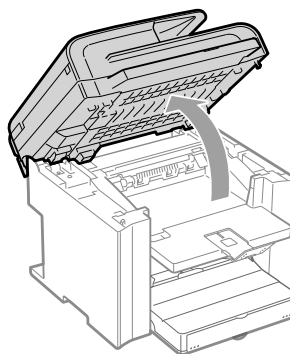

? **If you cannot lift the scanning platform**
Ensure that the feeder is completely closed.
Do not try to forcefully lift the scanning platform, as this may damage the machine.
* If you set thick documents such as a book, the feeder may not be completely closed. Remove the documents.

- 3** Hold the grip on the left front side of the toner cover.

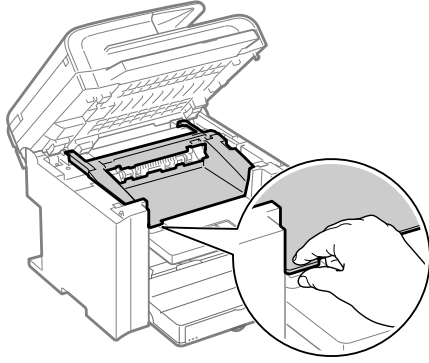

- 4** Open the toner cover.

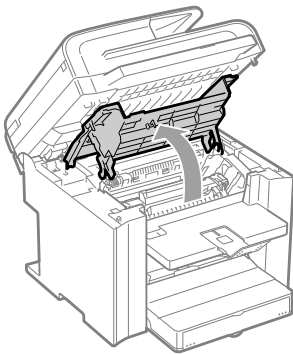

- 5** Remove the toner cartridge.

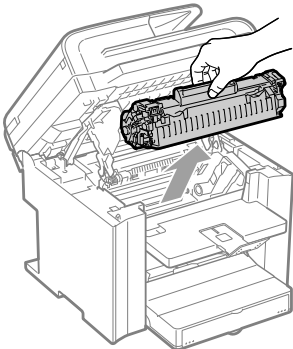

- 6** Take out the new toner cartridge from the protective bag.

You can open the protective bag with your hands from the notch.

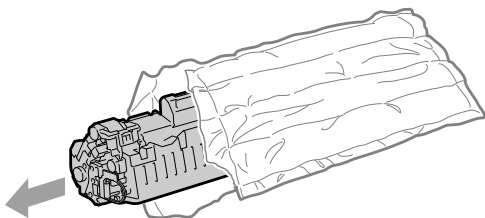

- 7** Gently shake the toner cartridge five or six times to evenly distribute the toner.

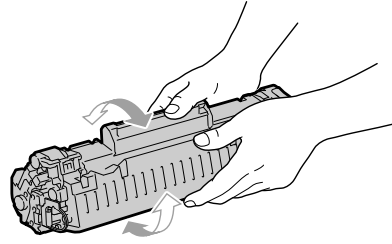

- 8** Place the toner cartridge on a flat surface, lift the tab, and gently pull the sealing tape completely out.

The full length of the sealing tape is approximately 20" (50 cm).

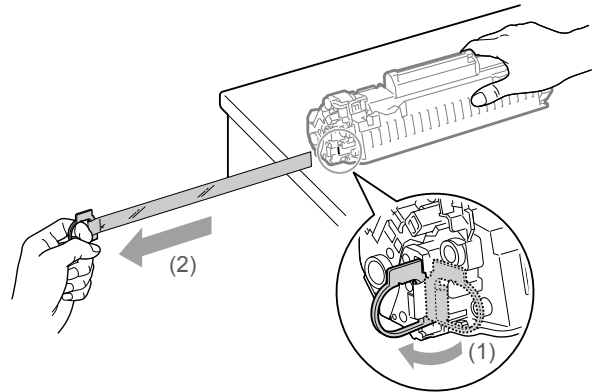

- 9** Insert the toner cartridge.

Fit the protrusions (A) on each side of the toner cartridge into the guides located on each side of the machine, and then slide the toner cartridge into the machine until the toner cartridge meets the back of the machine.

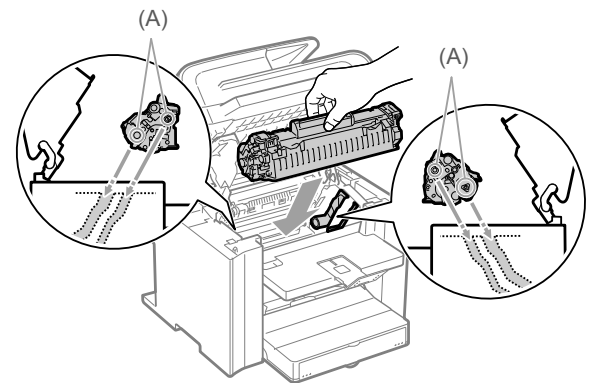

10 Close the toner cover.



If you cannot close the toner cover

Ensure that the toner cartridge is properly set in the machine.
Do not try to forcefully close the toner cover, as this may damage the machine.

11 Lower the scanning platform.

Precautions when Replacing Toner Cartridge

See "Maintenance and Inspections" (→P.viii) in "Important Safety Instructions" as well.

WARNING

Do not dispose of a used toner cartridge in open flames

This may cause the toner remaining inside the cartridges to ignite, resulting in burns or fire.

CAUTION

Precautions if you get toner on your hands or clothing

If toner gets on your hands or clothing, wash them immediately with cold water.
Washing with warm water sets the toner, making it impossible to remove the toner stains.

Be careful not to allow the toner to scatter

Do not pull out the sealing tape forcefully or stop at midpoint, as this may cause toner to spill out.
If toner gets into your eyes or mouth, wash them immediately with cold water and consult a physician.

Precautions when lowering the scanning platform

Be careful not to catch your fingers.



IMPORTANT

About replacement toner cartridge

For optimum print quality, replacement is recommended using genuine Canon toner cartridge.

Model name	Supported Canon genuine toner cartridge
D550	Canon Cartridge 128

Shake the toner cartridge before setting

If toner is not distributed evenly, this may result in a deterioration in print quality.

Hold the toner cartridge properly

When handling the toner cartridge, hold them properly as shown in the figure. Do not place them vertically or upside-down.

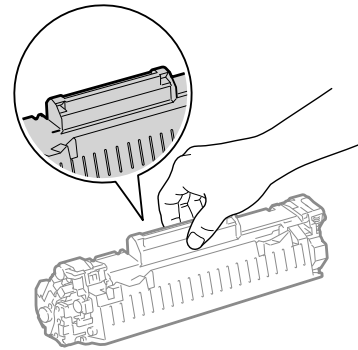

Do not touch the toner cartridge memory (A) or the electrical contacts (B)

This may result in damage to the cartridge.

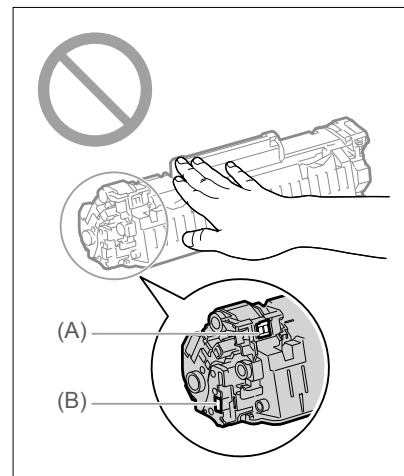

Do not open the drum protective shutter (A).

Print quality may deteriorate if you touch or damage the drum inside of the drum protective shutter (A). Do not touch or open the drum protective shutter (A).

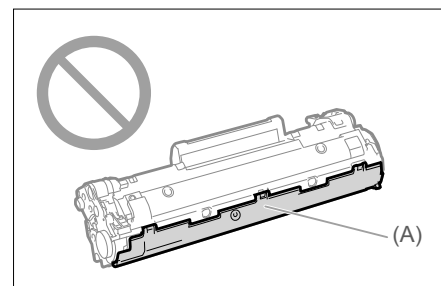

When pulling out the sealing tape

- Do not pull the sealing tape diagonally or sideways. If the tape breaks, this may become difficult to pull out completely.

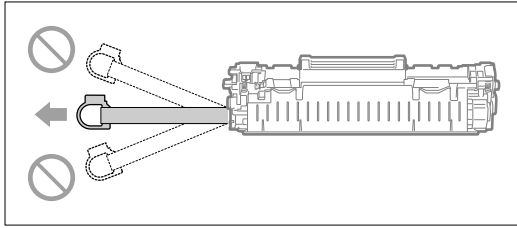

- Even if the sealing tape stops at midpoint, pull it out of the toner cartridge completely.
- If any tape remains in the toner cartridge, this may result in poor print quality.

Disposing of the removed sealing tape

Dispose of the sealing tape according to local regulations.

Keep the protective bag

Keep the protective bag for the toner cartridge. You will need them when you remove the toner cartridge for machine maintenance or other purposes.

Do not touch the high-voltage contacts (A)

This may result in damage to the machine.

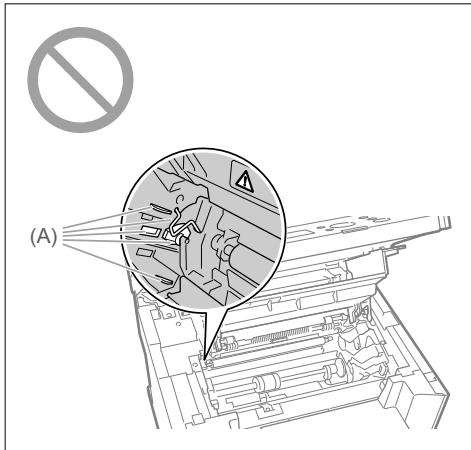
**Do not leave the toner cover open for a long time with the toner cartridge installed.**

This may result in a deterioration in print quality.

**NOTE****About the packing materials**

The packing materials may be changed in form or placement, or may be added or removed without notice.

Collecting used toner cartridges

- ▶ "Recycling Used Cartridges" (→P.6-13)

Purchase Consumables

Purchase at your local authorized Canon dealer.
If you are not sure, contact the Canon help line.

Recycling Used Cartridges

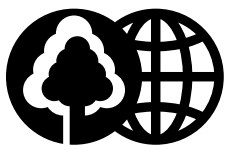

Canon has instituted a worldwide recycling program for cartridges called "The Clean Earth Campaign". This program preserves precious natural resources by utilizing a variety of materials found in the used cartridges that are of no further use, to remanufacture new cartridges which, at the same time, keeps the environment cleaner by reducing landfill waste. Complete details concerning this program are enclosed in each Cartridge box.

The Clean Earth Campaign

THE Canon CARTRIDGE RECYCLING PROGRAM

The Canon Cartridge Recycling Program fulfills the first initiative of Canon's Clean Earth Campaign, which supports four critical environmental areas:

- Recycling in the Workplace
- Conserving Environmental Resources
- Scientific Research and Education
- Encouraging Outdoors Appreciation

The remaining "Clean Earth" initiatives are supported in the U.S. through sponsorships of the National Park Foundation, the National Wildlife Federation, and The Nature Conservancy and in Canada through donations to the World Wildlife Fund Canada and The Nature Conservancy of Canada.

Since its inception, The Canon Cartridge Recycling Program has collected huge amount of cartridges that otherwise would have been discarded into landfills or similar facilities. Instead, this rapidly growing program returns used cartridges to the manufacturing process, thus conserving an array of resources. Becoming a part of this worthwhile program is easy. When your cartridge is of no further use, simply follow the instructions detailed for U.S. or Canadian residents.

We appreciate your support of The Canon Cartridge Recycling Program.

Working together we can make a significant contribution to a cleaner planet.

- Cartridges collected through this program are not refilled.
- You are not entitled to a tax deduction or rebate for the return of empty cartridges.
- This program may be modified or discontinued without notice.

The Clean Earth Campaign

Supporting Environmental Initiatives With

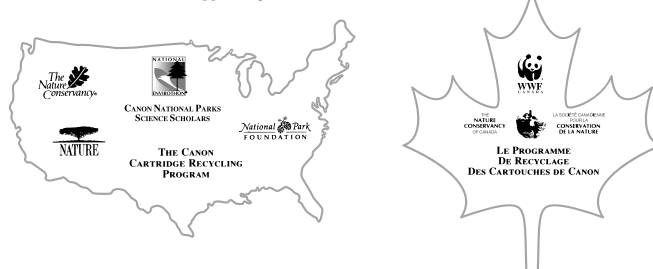

U.S.A. PROGRAM

Packaging

Option A-1: Single Box Return

- Repackage the empty cartridge utilizing the wrapper and pulp mould end-blocks from the new cartridge's box.
- Place the empty cartridge in the box of your new cartridge. Seal the box.

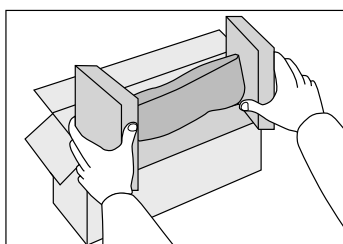

● Option B: Volume Box Return

We encourage you to use this option as a more efficient way to ship cartridges.

- Place as many cartridges as possible into one box.
Carefully seal the box with tape;
or
- Call **1-800-OK-Canon** to receive your free eight cartridge collection box.

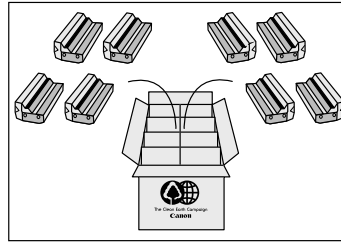

● Option A-2: Multiple Box Return

We encourage you to use this option as a more efficient way to ship cartridges.

- Complete Option A-1.
- Bundle multiple cartridge boxes together securely with tape.

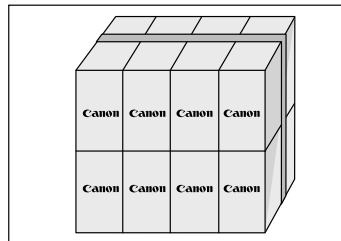

Please be sure that the shipment does not exceed UPS specifications.

Maximum weight = 70 lb. (31.8 kg)

Maximum length = 108" (2,743 mm)

Maximum girth (length + 2 x width + 2 x height) = 130" (3,302 mm)

If your shipment exceeds the above limits, please call 1-800-OK-Canon for special shipping information.

Please Note:

Do not send defective cartridges for replacement.

Defective cartridges under warranty should be exchanged by an authorized dealer or service facility as provided in the warranty.

Shipping

Apply the UPS authorized returning label provided in this guide.

Residents of Alaska and Hawaii: Do not use the UPS authorized returning label. For Alaska and Hawaii Canon set up alternative mail service with the U.S. Postal Service.

Please call 1-800-OK-Canon to receive U.S. Postal Service merchandise returning label.

- Give the shipment to your UPS driver when you receive your next regular delivery; (UPS may charge a fee for customers who call UPS to pick up a cartridge shipment if they do not already have a delivery scheduled.)
or
- Take the shipment to your local UPS receiving point.



CANADA PROGRAM-CANADA PROGRAMME

● Option A: Single Box Return

- Repackage the empty cartridge utilizing the wrapper and pulp mould end-blocks from the new cartridge's box.
- Place the empty cartridge in the box of your new cartridge. Seal the box.
- Apply the Canon Canada Inc./Canada Post label provided in this brochure. Canon's labels are specially marked so that Canon pays the postage.
- Deposit your empty cartridge in any full size street mailbox or take it to your local Canada Post outlet or franchise.

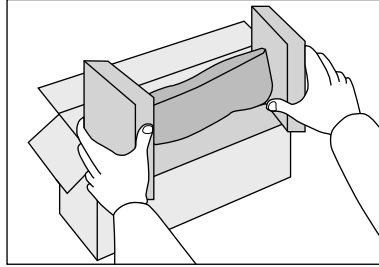

● Option B: Volume Box Return (eight or more cartridges)

We encourage you to use this option as a more efficient way to ship cartridges.

- Call **1-800-667-2666** to receive your free Canon collection box kit.
- The collection box can accommodate eight individual cartridge boxes.
- Place your eight individually packaged boxes of empty cartridges into the Canon collection box. Seal the box.
- Apply the Canon Canada Inc./Canada Post label provided in this brochure.
- Canon's labels are specially marked so that Canon pays the postage.
- Deliver to any local Canada Post outlet or franchise. Customers who hold a Commercial pick-up agreement with Canada Post may have their collection box picked up.

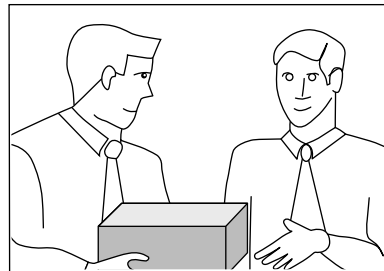
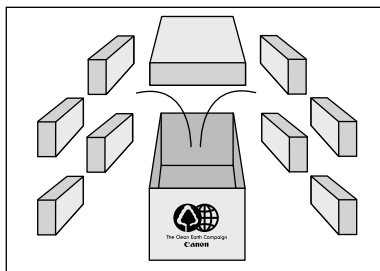

Working to preserve endangered species is a long-standing Canon interest.

To this end, for every cartridge collected, Canon Canada donates \$1, shared equally between World Wildlife Fund Canada and the Nature Conservancy of Canada. This donation is utilized in Canada.

- For further information about The Clean Earth Campaign in Canada, please call or write to Canon.

1-800-667-2666

Canon Canada Inc.
Corporate Customer Relations
6390 Dixie Road
Mississauga, ON L5T 1P7

Transporting the Machine

Before transporting the machine, see "Precautions when Transporting the Machine" (→P6-17)

When changing the location of the machine or moving the machine for maintenance, be sure to perform the following procedure.

- 1 Turn OFF the machine and any connected computer.

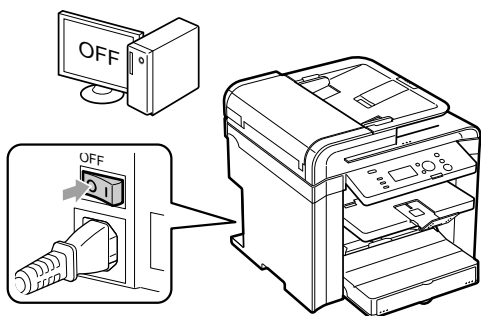

- 2 Disconnect all cables and the power cord from the machine.

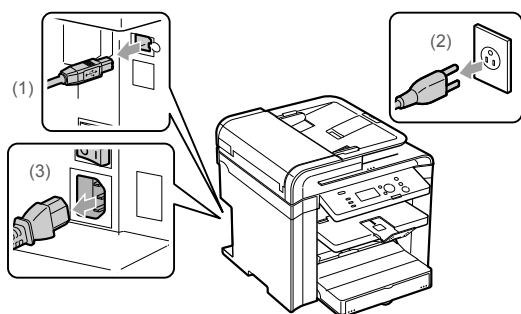

How to remove the cables and cord

USB cable*	(1) Remove it from the machine.
Power cord	(2) Unplug the power plug from the AC power outlet. (3) Remove it from the machine.

* Whether the cable is connected or not varies depending on your environment.

- 3 Fold the paper stopper, and then push the output tray extension into the machine.

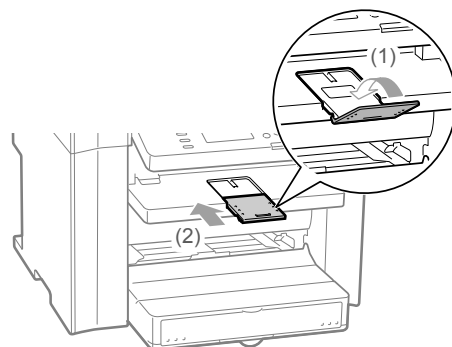

NOTE

If paper is in the output tray

Remove the paper from the output tray.

- 4 Lift the dust cover.

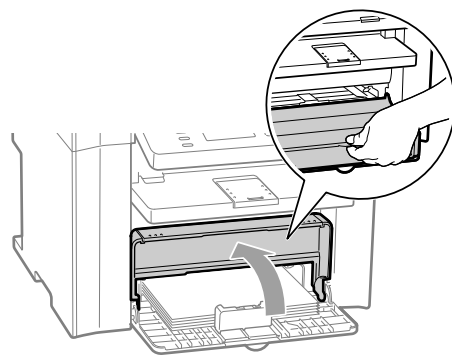

NOTE

If paper is set in the multi-purpose tray

Remove the paper from the multi-purpose tray.

5 Remove any paper from the paper cassette.

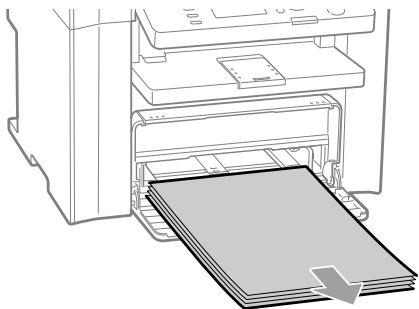

NOTE

If the paper guide at the front projects from the paper cassette

Push the paper guide into the paper cassette.

6 Lower the dust cover.

7 Close the paper cassette.

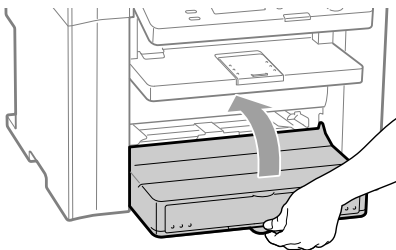

8 Move the machine.

Ensure that all covers and trays are closed, and hold the lift handles with the front side of the machine facing you.

Check the weight of the machine to carry it safely.

▶ "Main Specifications" (→P.9-2)

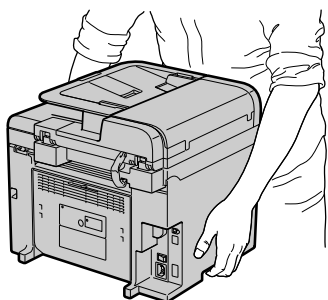
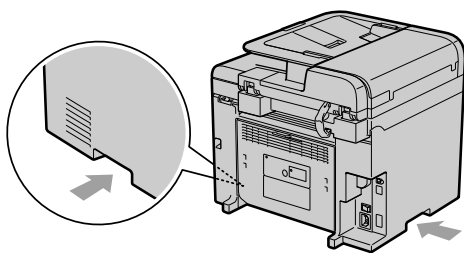

9 Carefully set the machine down on the new installation site.



NOTE

When reinstalling the machine

Refer to the supplied Starter Guide.

When transporting the machine long distance

To prevent damage to the machine during transportation, refer to the following.

- Remove the toner cartridge.
- Securely pack the printer in its original box with the original packing materials.
- * If the original box and packing materials are not available, find an appropriate box along with packing materials and pack the machine and the parts appropriately.

Precautions when Transporting the Machine

! WARNING

When transporting the machine

Be sure to turn off the power switches of the machine and your computer, and then unplug the power plug and interface cables.

Failure to do so can damage the cables or cords, resulting in a fire or electrical shock.

! CAUTION

Set the machine down slowly and carefully.

Be careful not to hurt your hands or fingers.



IMPORTANT

Do not carry the machine with covers or trays open.

Make sure that the scanning platform and paper cassette are closed before carrying the machine.

Troubleshooting

This section describes solutions for cases such as paper jam and when problems are not solved.

Clearing Jams	7-2
Document Jams in the Feeder	7-3
Paper Jams Inside the Machine	7-4
Display Message	7-7
Error Codes	7-7
If <Incorrect Size/Setting> Appears	7-8
Troubleshooting	7-9
Check the Following First	7-9
Is the power switched ON?	7-9
Has the power switch been just turned ON?	7-9
Is the machine in Sleep mode?	7-9
Are the settings proper?	7-9
Is the Error indicator on or blinking?	7-9
Does a message appear on the display?	7-10
If You Cannot Solve a Problem	7-10
If a Power Failure Occurs	7-11
If You Cannot Solve a Problem	7-12
Customer Support (U.S.A.)	7-12
Customer Support (Canada)	7-12
Print Result Is Not Good	7-13
Paper Curls	7-13
Paper Creases	7-13
Printing Is Uneven	7-14
White Specks Appear	7-15
The Toner Does Not Fix onto the Paper Well	7-15
The Printed Paper Has Vertical Streaks	7-16
Smudge Marks or Spattering Toner Appear around the Text or Patterns	7-17
The Overall Print Result Is Dark	7-17
Copied Lines and Text Appear Faded	7-18
Printed Bar Codes Cannot Be Scanned	7-18
Paper Jams Occur Frequently When Performing 2-Sided Printing	7-18

Clearing Jams

Keys to be used for this operation

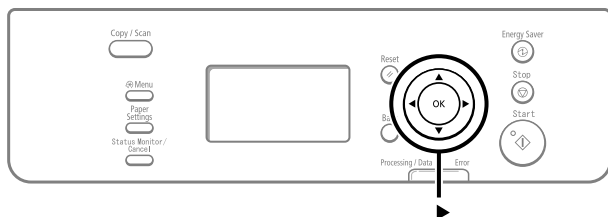

When <Paper jam.> appears on the display, a paper jam has occurred in the feeder or inside the machine. To remove the jammed document or paper, follow the instructions on the display. Press [▶] to view the next step.

⚠ Paper jam.
Press [▶] to display steps. ▶

- ▶ "Document Jams in the Feeder" (→P.7-3)
- ▶ "Paper Jams Inside the Machine" (→P.7-4)

⚠ WARNING

When removing the jammed document or paper

Use caution to avoid cutting your hands.

When removing jammed paper or when inspecting the inside of the machine

Do not allow necklaces, bracelets, or other metal objects to touch the inside of the machine, as this may result in burns or electrical shock.

⚠ CAUTION

If loose toner comes into contact with your skin or clothing

Wash with cold water. Avoid warm water, as this will set the toner and cause it to stain your skin or clothing.

When removing the jammed document or paper

If paper is jammed, remove the jammed paper so that any pieces of paper do not remain inside the machine according to the displayed message. Also, do not put your hand in an area other than indicated areas, as this may result in personal injuries or burns.

Do not touch the fixing unit (A).

Touching the fixing unit (A) may cause burns as it becomes very hot during use.

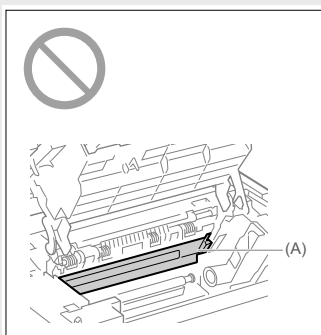

⚠ IMPORTANT

If the jammed paper is torn

Remove all torn pieces to avoid further jams.

If repeated paper jams occur

Check the following.

- Ensure that the following packing material is completely removed.

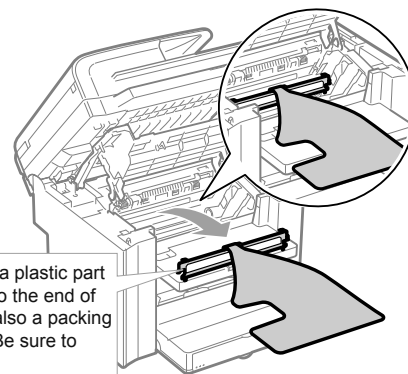

- Fan the paper stack and tap the edge on a flat surface to align the paper before loading it into the machine.
- Ensure that the paper you are using meets the requirements for use.
 - ▶ "Paper Requirements" (→P.2-6)
- Ensure that you have removed all scraps of paper from the inside of the machine.

Do not touch the transfer roller (A).

Touching the transfer roller (A) may damage the machine.

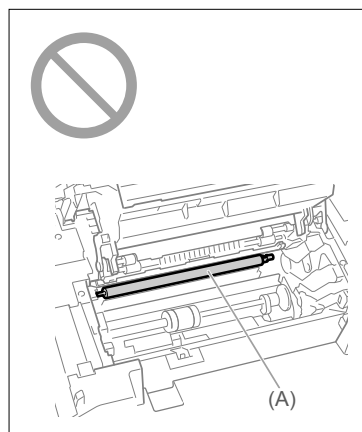

⚠ NOTE

Do not force the jammed document or paper out of the machine

Contact your local authorized Canon dealer or the Canon help line for assistance, if needed.

Document Jams in the Feeder

Referring to the procedure on the display, follow the steps below to remove jammed documents.

1 Remove any document loaded in the feeder.

2 Open the feeder cover.

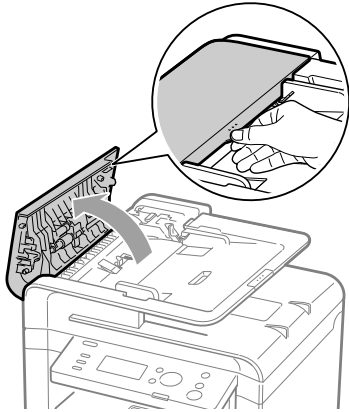

3 Lift the lock release lever (A).

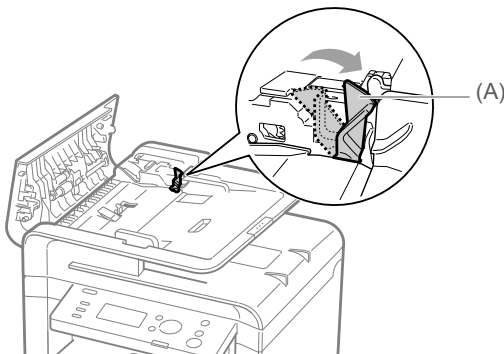

4 Remove any jammed document by pulling it gently.

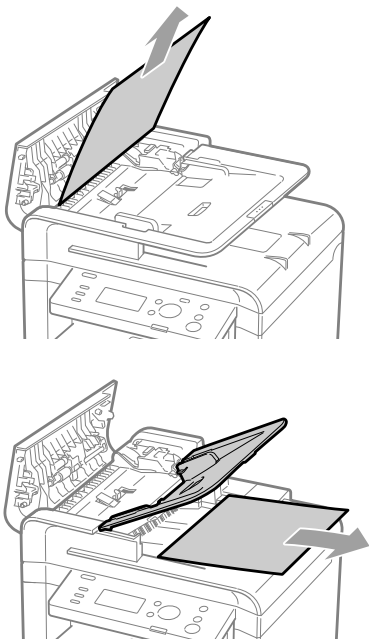

5 Hold the green grip (A), and then open the inner cover.

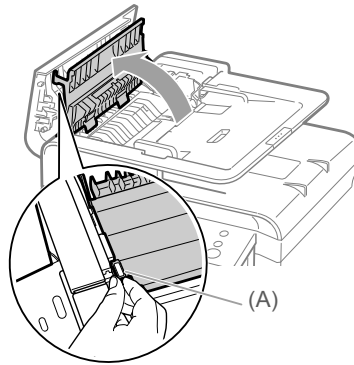

6 Remove any jammed document by pulling it gently.

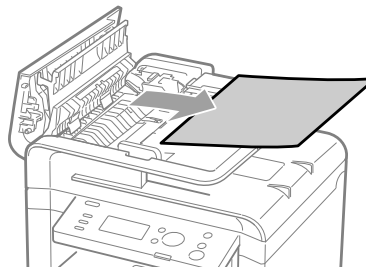

7 Close the inner cover.

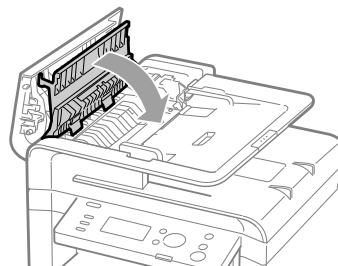

8 Replace the release lever (A).

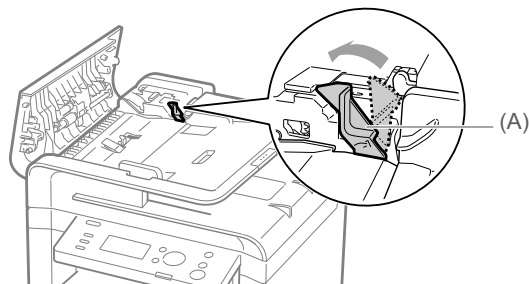

- 9** Close the feeder cover.

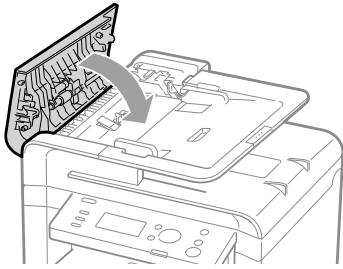

- 10** Place documents in the feeder.

Paper Jams Inside the Machine

Referring to the procedure on the display, follow the steps below to remove jammed paper.

- 1** Hold the operation panel.

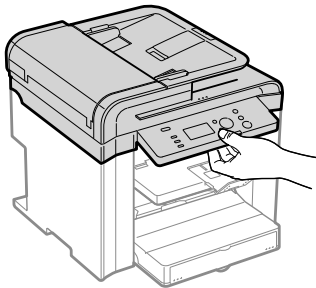

- 2** Lift the scanning platform.

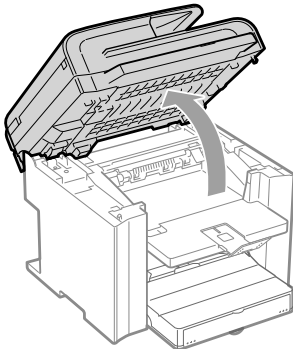

- ?** **If you cannot lift the scanning platform**

Ensure that the feeder is completely closed.
Do not try to forcefully lift the scanning platform, as this may damage the machine.
* If you set thick documents such as a book, the feeder may not be completely closed. Remove the documents.

- 3** Hold the grip on the left front side of the toner cover.

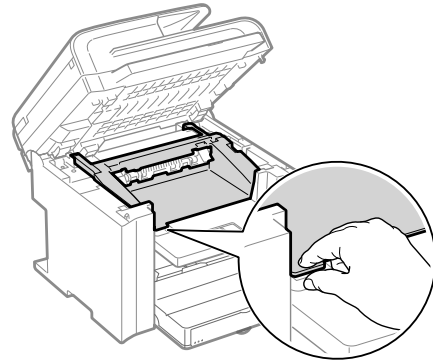

- 4** Open the toner cover.

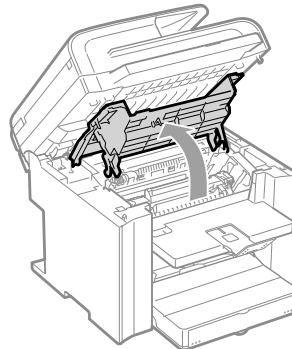

- 5** Remove the toner cartridge.

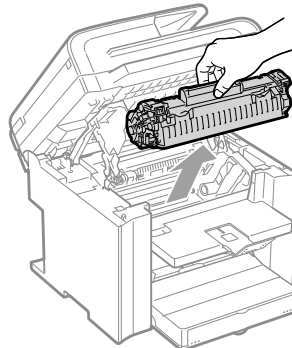

- 6** Remove any jammed paper by pulling it gently.

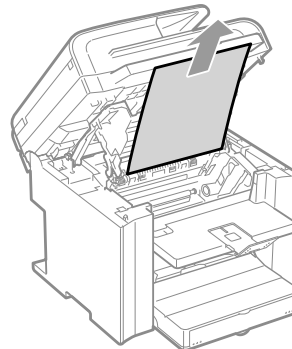

If you do not see the leading edge of the jammed paper
Do not force to pull the paper, and proceed to step 7.

- 7** Push up the green colored part (A), and then pull the paper exit guide to open.

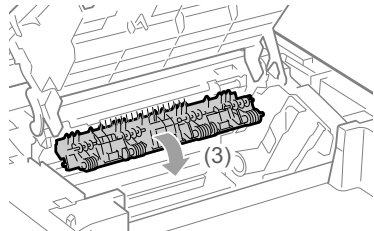
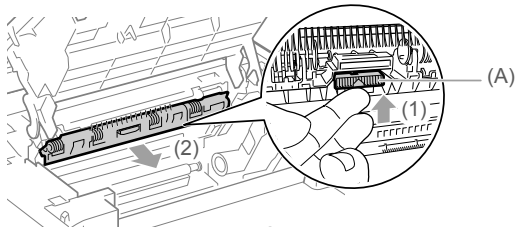

- 8** Remove any jammed paper by pulling it gently.

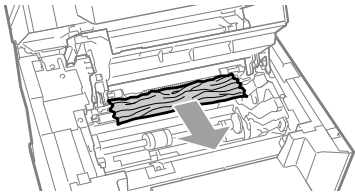

If you do not see the leading edge of the jammed paper
Do not force to pull the paper, and proceed to step 9.

- 9** Lift the paper exit guide, and then firmly close it.

Ensure that each end of the paper exit guide is closed.

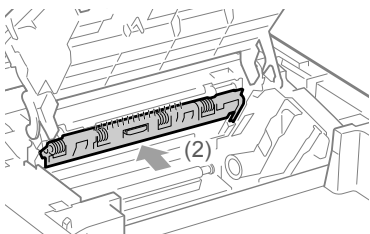
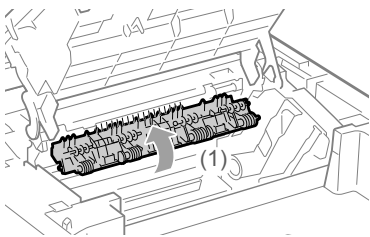

- 10** Remove any jammed paper by pulling it gently.

(1) Gently pull any jammed paper downward from between the fixing unit (A) and transfer roller (B) until the leading edge emerges from the machine.

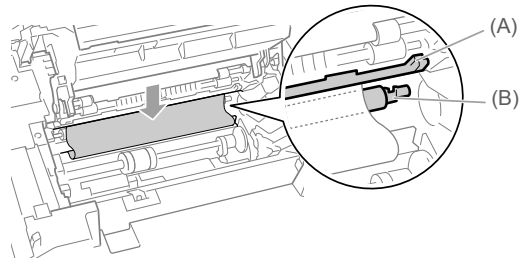

(2) When the leading edge emerges, hold both sides of the jammed paper and carefully pull it out.

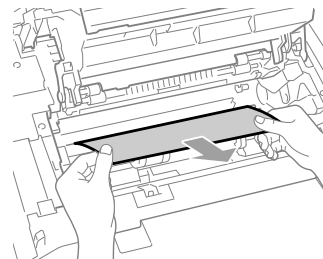

- 11** Remove any jammed paper by pulling it gently.

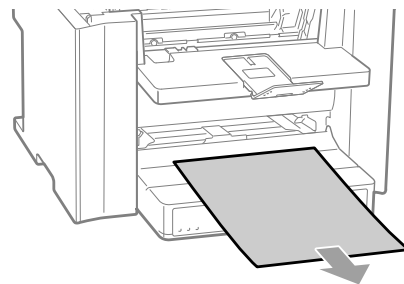

- 12** Lift the dust cover.

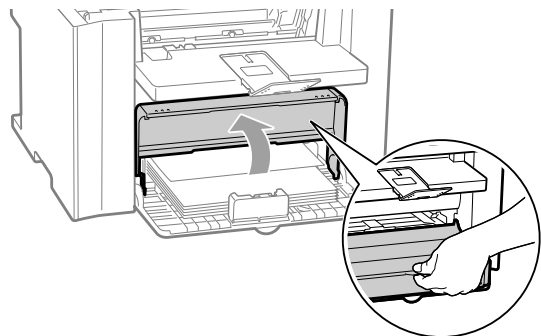

13 Remove any paper loaded in the paper cassette.

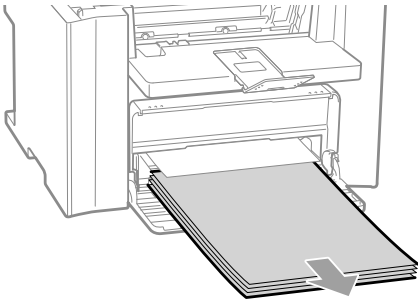

14 Remove any jammed paper by pulling it gently.

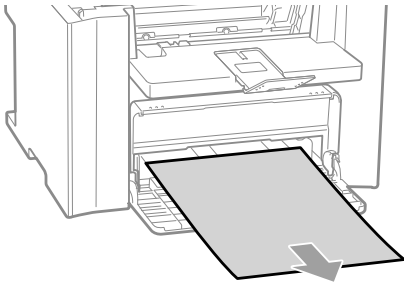

15 Reload paper into the paper cassette and lower the dust cover.

 Next, continue to clear jams in the rear cover.

16 Open the rear cover.

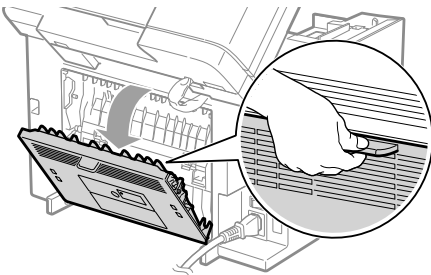

17 Remove any jammed paper by pulling it gently.

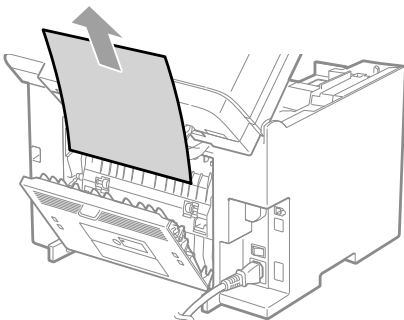

18 Close the rear cover.

19 Insert the toner cartridge.

Fit the protrusions (A) on each side of the toner cartridge into the guides located on each side of the machine, and then slide the toner cartridge into the machine until the toner cartridge meets the back of the machine.

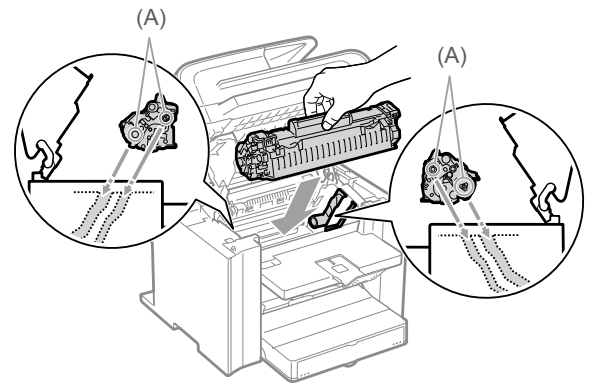

20 Close the toner cover.



If you cannot close the toner cover

Ensure that the toner cartridge is properly set in the machine. Do not try to forcefully close the toner cover, as this may damage the machine.

21 Lower the scanning platform.

The machine is ready to print.

● Display Message

If messages appear, see the following and solve the problem.

📖 e-Manual → Troubleshooting → Display Messages

● Error Codes

An error code is a 3-digit code recorded as an error log when an error occurs.

You can view the code at the job history in the system status screen.

For details on the error code, see the following.

#001	Cause	A document may be jammed.
	Action	Remove the jammed document.
#037	Cause 1	The machine's memory is full.
	Action 1	Print, send, or delete any documents stored in the memory.
	Action 2	For a copy job, divide the document into two or set <Original Type> to <Text/Photo (High Speed)> before copying. 📖 e-Manual → Copy → Selecting Image Quality (Copy)
	Cause 2	The data size exceeds the machine's available memory.
	Action	Reduce the data resolution or change the file format to reduce the data volume.



If <Incorrect Size/Setting> Appears

The message appears when the paper size specified in <Drawer 1>, or <MP Tray> in the <Paper Settings> menu is different from the size of the paper loaded in the paper cassette or multi-purpose tray. If the message appears, perform the following operations.



NOTE

When printing using the printer driver

To ignore the message and proceed to print on paper that is currently set, press [▲] or [▼] to select <Resume>, and then press [OK]. However, images may be printed improperly, for example, part of images may not be printed.

Change the <Paper Settings> menu according to the size of the loaded paper.

Cancel the job, see "Setting a Paper Size and Type" (→P.2-14), and then change <Paper Settings>.



IMPORTANT

When printing using the printer driver

Check that the paper size setting on the computer is also correct.

Loading paper of the size specified in the <Paper Settings> menu.

- (1) See "Loading Paper" (→P.2-9) and reload the paper specified in the <Paper Settings> menu.
- (2) Press [▲] or [▼] to select <Resume>, and then press [OK].

Troubleshooting

If one of the following problems occurs during use, try the actions suggested here before contacting technical support.

Check the Following First

Is the power switched ON?

Ensure that the power cord is securely plugged into the machine and into the wall outlet.

Ensure that electricity is supplied from the power cord. Use another power cord or verify that cord is broken using a voltmeter.

Turn ON the power switch.

If there is no problem



Has the power switch been just turned ON?

Wait a moment for the machine starts and warm up.

If there is no problem



Is the machine in Sleep mode?

Press [] (Energy Saver) on the operation panel to exit the Sleep mode.

If there is no problem



Are the settings proper?

If the machine emits the entry error tone and does not start operating when you press [] (Start), your combination of settings may be invalid. Recheck the settings.

If there is no problem



Is the Error indicator on or blinking?

Ensure that paper is loaded properly in the paper cassette or multi-purpose tray.

 "Loading Paper" (→P.2-9)

Check if paper is jammed.

 "Clearing Jams" (→P.7-2)

Turn OFF the power switch of the machine, wait for more than 10 seconds, and then turn it ON. If the problem is solved, the Error indicator will turn off and the display will return to standby mode. If the Error indicator keeps blinking, unplug the power cord and contact your local authorized Canon dealer or the Canon help line.

If there is no problem



Does a message appear on the display?

If an error message appears on the display, refer to the following section to locate the appropriate corrective action.

▶ "Display Message" (→P.7-7)

Print the transmission management report to see if any errors are listed.

📖 e-Manual → Basic Operation → Printing a List → Printing a Communication Management Report

If there is no problem



If You Cannot Solve a Problem

See "Troubleshooting" in the e-Manual, then solve the problem.

● If a Power Failure Occurs

The machine cannot be used while power supply is cut off.



NOTE

Charging the built-in battery

It takes approximately 24 hours to fully charge the built-in battery after the machine is turned ON.

If the built-in battery has not been charged fully charged, documents stored in the memory may not be properly backed up.

If You Cannot Solve a Problem

Customer Support (U.S.A.)

If you cannot solve the problem after having referred to the information in this chapter, contact Canon Customer Care Center at 1-800-OK-CANON Monday through Friday between the hours of 8:00 A.M. to 8:00 P.M. EST. On-line support is also available 24 hours a day at the website <http://www.canontechsupport.com>.

Please have the following information ready when you contact Canon:

- Product name (imageCLASS D550)
- Serial number (a character string which consists of three alphabets and a 5-digit number and is indicated on the rating label located on the rear side of the machine)

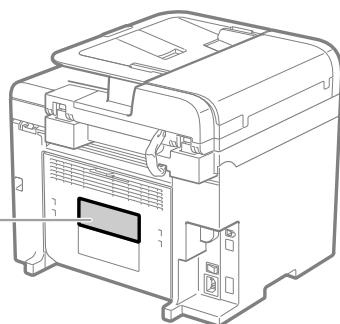

Rating label

- Place of purchase
- Nature of problem
- Steps you have taken to solve the problem and the results

WARNING

If the machine makes strange noises or emits smoke or odd odor

Turn OFF the power switch immediately, disconnect the power cord, and contact Canon Customer Care Center. Do not attempt to disassemble or repair the machine yourself.

IMPORTANT

If you attempt to repair the machine by yourself

It may void the limited warranty.

Customer Support (Canada)

Canon Canada Inc., offers a full range of customer technical support options*:

- * Support program specifics are subject to change without notice.
- For step-by-step troubleshooting, e-mail technical support, the latest driver or document downloads, and answers to frequently asked questions, visit <http://www.canon.ca/>
- Free live technical support 9 A.M. to 8 P.M. EST Monday through Friday (excluding holidays) for products still under warranty 1-800-OK-CANON
- For the location of the authorized service facility nearest you, visit <http://www.canon.ca/> or 1-800-OK-CANON
- If the problem cannot be corrected by using one of the above technical support options, repair options are available at the time of your call to the live technical support number above or via the website at <http://www.canon.ca/>
- * Support program specifics are subject to change without notice.

Please have the following information ready when you contact Canon:

- Product name (imageCLASS D550)
- Serial number (a character string which consists of three alphabets and a 5-digit number and is indicated on the rating label located on the rear side of the machine)

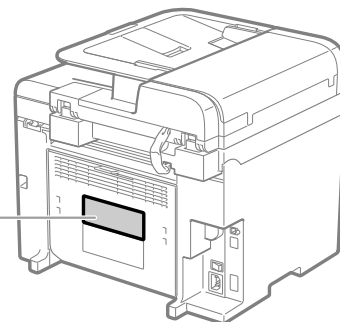

Rating label

- Place of purchase
- Nature of problem
- Steps you have taken to solve the problem and the results

WARNING

If the machine makes strange noises or emits smoke or odd odor

Turn OFF the power switch immediately, disconnect the power cord, and contact Canon Customer Care Center. Do not attempt to disassemble or repair the machine yourself.

IMPORTANT

If you attempt to repair the machine by yourself

It may void the limited warranty.

Print Result Is Not Good



NOTE

Contacting your local authorized Canon dealer

If a problem that is not indicated in the e-Manual occurs, if none of the suggested measures solve the problem, or if you cannot determine the problem, contact your local authorized Canon dealer.

Paper Curls



Perform one of the following solutions according to the cause.

<Cause 1> Damp paper is used.

Solution 1	Replace the paper with new paper in an unopened package. ▶ "Paper Requirements" (→P.2-6)		
Solution 2	Perform the following procedure in the printer driver when you are using plainpaper (60 to 90 g/m2). 1. Display the [Page Setup] tab. 2. Set [Paper Type] to [Plain Paper L].		
Solution 3	Change the <Special Mode V> settings from the operation panel. ☞ e-Manual → Maintenance → Special Mode The level of improvement according to the setting option is as following. <table border="1" style="margin: 10px auto;"> <tbody> <tr> <td style="text-align: center;"><Off> → <Mode 1> → <Mode 2> → <Mode 3></td> </tr> <tr> <td style="text-align: center;">(low) (high)</td> </tr> </tbody> </table> <ul style="list-style-type: none"> * Change of paper type or environment may reduce the curl or wrinkle problem, even without changing the setting. * This setting is available when <ul style="list-style-type: none"> • the <Paper Size> is set to <B5>, <A5>, <STMT>, or <EXEC> • the <Paper Type> is set to <Plain (16 lb Bond-24 lb Bond)>, <Plain L (16 lb Bond-24 lb Bond)>, <Recycled>, <Color>, <Rough 1 (16 lb Bond-24 lb Bond)>, or <Envelope> * As you select an option that has higher effect, printing speed becomes slower. 	<Off> → <Mode 1> → <Mode 2> → <Mode 3>	(low) (high)
<Off> → <Mode 1> → <Mode 2> → <Mode 3>			
(low) (high)			

<Cause 2> Appropriate paper is not being used.

Solution	Replace the paper with which can be used with this printer. ▶ "Paper Requirements" (→P.2-6)
-----------------	--

Paper Creases



Perform one of the following solutions according to the cause.

<Cause 1> The paper is not loaded properly.

Solution	Load the paper properly. ▶ "Loading Paper" (→P.2-9)
-----------------	--

<Cause 2> Damp paper is used.

Solution	Replace the paper with new paper in an unopened package. ▶ "Paper Requirements" (→P.2-6)
-----------------	---

<Cause 3> Appropriate paper is not being used.

Solution	Replace the paper with which can be used with this printer. ▶ "Paper Requirements" (→P.2-6)
-----------------	--

<Cause 4> There is a foreign object inside the printer.

Solution	Remove the foreign object inside the printer.
-----------------	---

<Cause 5> Depending on the paper type or the operating environment, the paper may be creased.

Solution	Change the <Special Mode V> settings from the operation panel. 📖 e-Manual → Maintenance → Special Mode The level of improvement according to the setting option is as following. <table border="1" data-bbox="399 772 845 840"><tr><td><Off></td><td>→</td><td><Mode 1></td><td>→</td><td><Mode 2></td><td>→</td><td><Mode 3></td></tr><tr><td>(low)</td><td></td><td></td><td></td><td></td><td></td><td>(high)</td></tr></table> <ul style="list-style-type: none">* Change of paper type or environment may reduce the curl or wrinkle problem, even without changing the setting.* This setting is available when<ul style="list-style-type: none">• the <Paper Size> is set to <B5>, <A5>, <STMT>, or <EXEC>• the <Paper Type> is set to <Plain (16 lb Bond-24 lb Bond)>, <Plain L (16 lb Bond-24 lb Bond)>, <Recycled>, <Color>, <Rough 1 (16 lb Bond-24 lb Bond)>, or <Envelope>* As you select an option that has higher effect, printing speed becomes slower.	<Off>	→	<Mode 1>	→	<Mode 2>	→	<Mode 3>	(low)						(high)
<Off>	→	<Mode 1>	→	<Mode 2>	→	<Mode 3>									
(low)						(high)									

Printing Is Uneven

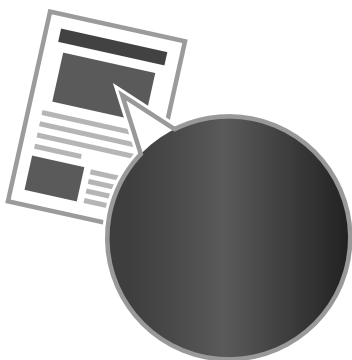

Perform one of the following solutions according to the cause.

<Cause 1> Paper is too moist or Too dry.

Solution	Replace the paper with new paper in an unopened package. ▶ "Paper Requirements" (→P.2-6)
-----------------	---

<Cause 2> Toner is nearly out.

Solution	To view the solution, refer to the following. ▶ "Replacing the Toner Cartridge" (→P.6-9)
-----------------	---

<Cause 3> The drum in the toner cartridge is deteriorated.

Solution	Replace the toner cartridge with a new one. ▶ "Replacing the Toner Cartridge" (→P.6-9)
-----------------	---

<Cause 4> Unevenness may appear when thin lines are printed.

Solution	Change the <Special Mode J> setting to <On> from the operation panel. ☞ e-Manual → Maintenance → Special Mode * If you use this mode, the following problems may occur. <ul style="list-style-type: none">• The output is less fine.• Toner smears even on unnecessary parts.• Toner consumption increases.
-----------------	---

White Specks Appear



Perform one of the following solutions according to the cause.

<Cause 1> Appropriate paper is not being used.

Solution	Replace the paper with which can be used with this printer. ☞ "Paper Requirements" (→P.2-6)
-----------------	--

<Cause 2> Damp paper is used.

Solution	Replace the paper with new paper in an unopened package. ☞ "Paper Requirements" (→P.2-6)
-----------------	---

<Cause 3> The drum in the toner cartridge is deteriorated.

Solution	Replace the toner cartridge with a new one. ☞ "Replacing the Toner Cartridge" (→P.6-9)
-----------------	---

<Cause 4> When you print a document of highly contrasting density, white specks may appear on the outlines of the text or images.

Solution	Change the [Special Print Mode] setting to [Special Settings 2] from the printer driver. ☞ e-Manual → Maintenance → Special Mode * When [Special Settings 2] is selected, printing density is lower than when [Off] or [Special Settings 1] is selected. Also, text or lines may be less clear.
-----------------	--

The Toner Does Not Fix onto the Paper Well



Perform one of the following solutions according to the cause.

<Cause 1> Paper type setting is not specified properly.

Solution	<p>Properly specify the paper type setting.</p> <ul style="list-style-type: none"> * If you are using coarse paper, select one of the followings. <ul style="list-style-type: none"> • <Rough 1 (16 lb Bond-24 lb Bond)> • <Rough 2 (24 lb Bond-32 lb Bond)> • <Rough 3 (45 lb Cover-60 lb Cover)> ☑ "Setting a Paper Size and Type" (→P.2-14)
----------	--

<Cause 2> Appropriate paper is not being used.

Solution	<p>Replace the paper with which can be used with this printer.</p> <p>☑ "Paper Requirements" (→P.2-6)</p>
----------	---

<Cause 3> Depending on the environment (in low temperature environments), toner may not be fixed sufficiently, and output may be less clear.

Solution	<p>Change the <Special Mode K> setting to <On> from the operation panel.</p> <p>☞ e-Manual → Maintenance → Special Mode</p> <ul style="list-style-type: none"> * Change of environment may improve the toner fixation, even without changing the setting. * If you use this mode, printing speed becomes slow.
----------	--

The Printed Paper Has Vertical Streaks



Perform one of the following solutions according to the cause.

<Cause 1> Depending on the paper type or the operating environment, vertical streaks may appear on the printed paper.

Solution 1	<p>Replace the paper with new paper in an unopened package.</p> <p>☑ "Paper Requirements" (→P.2-6)</p>		
Solution 2	<p>When copying Change the <Special Mode Z> setting from the operation panel.</p> <p>When printing from a computer Change the [Special Print Adjustment] setting from the print driver.</p> <p>☞ e-Manual → Maintenance → Special Mode</p> <p>The level of improvement according to the setting option is as following.</p> <table border="1" style="margin-left: 20px;"> <tr> <td style="text-align: left;"><Off> → <Mode 1> → <Mode 2> → <Mode 3> → <Mode 4></td> </tr> <tr> <td style="text-align: left;">(low) (high)</td> </tr> </table> <ul style="list-style-type: none"> * Change of paper type or environment may reduce the streaks, even without changing the setting. * As you select an option that has higher effect, printing density becomes lower. Outlines of printed text or images may be less clear, or images may be slightly jagged. 	<Off> → <Mode 1> → <Mode 2> → <Mode 3> → <Mode 4>	(low) (high)
<Off> → <Mode 1> → <Mode 2> → <Mode 3> → <Mode 4>			
(low) (high)			
Solution 3	<p>Change the <Special Mode D> setting to <On> from the print driver.</p> <p>☞ e-Manual → Maintenance → Special Mode</p> <ul style="list-style-type: none"> * Change of paper type or environment may reduce the streaks, even without changing the setting. * This mode is more effective than <Special Mode Z>, however, printing speed becomes slow. * This mode has higher priority than <Special Mode Z>. 		

<Cause 2> The toner cartridge was replaced, or the printer was not printed for a long period of time.

Solution	<p>Change the <Special Mode B> setting from the operation panel.  e-Manual → Maintenance → Special Mode The level of improvement according to the setting option is as following.</p> <table border="1" style="margin-left: 20px;"> <tr> <td style="padding: 2px;"><Off> → <Mode 1> → <Mode 2> → <Mode 3></td> </tr> <tr> <td style="padding: 2px;">(low) (high)</td> </tr> </table> <p>* Change of paper type or environment may reduce the streaks, even without changing the setting. * As you select an option that has higher effect, printing speed becomes slower.</p>	<Off> → <Mode 1> → <Mode 2> → <Mode 3>	(low) (high)
<Off> → <Mode 1> → <Mode 2> → <Mode 3>			
(low) (high)			

Smudge Marks of Spattering Toner Appear around the Text or Patterns



Perform one of the following solutions according to the cause.

<Cause 1> Appropriate paper is not being used.

Solution	<p>Replace the paper with which can be used with this printer.  "Paper Requirements" (→P.2-6)</p>
-----------------	---

<Cause 2> Depending on the paper type (especially for heavy paper) or the operating environment (especially in dry environments), smudge marks of spattering toner may appear.

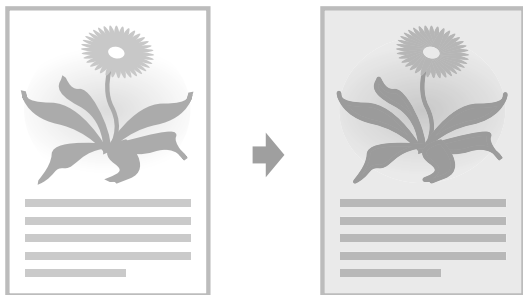

Solution	<p>Change the <Special Mode U> settings to <On> from the operation panel.  e-Manual → Maintenance → Special Mode</p> <ul style="list-style-type: none"> * Maintain this setting <Off> in normal conditions. Change the setting only when the problems mentioned above occur. * If you use this mode, printing quality may become lower depending on the paper type (especially for thin paper) or environment (especially in wet environments)
-----------------	--

The Overall Print Result Is Dark



Perform one of the following solutions according to the cause.

<Cause 1> The copy density is not properly set.

Solution	<p>Adjust the <Density> or <Correct Density> lower from the operation panel.  "Adjusting the Density" (→P.3-4)  e-Manual → Copy → Adjusting the Density → Finely Adjusting the Density</p>
-----------------	--

<Cause 2> The machine is exposed to direct sunlight or strong light.

Solution	Move the machine.  e-Manual → Maintenance → Transporting the Machine
-----------------	--

Copied Lines and Text Appear Faded

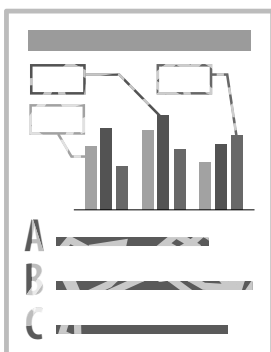

Perform the following procedure.

<Cause> <Original Type> is set to <Text/Photo (High Speed)> (default).

Solution	Set <Original Type> to <Text>, and then try to copy again.  "Selecting Image Quality (Copy)" (→P.3-4)
-----------------	---

Printed Bar Codes Cannot Be Scanned



Perform the following procedure.

<Cause> When printing a bar code with the default printing preferences, the bar code may not be able to be scanned.

Solution	Change the [Special Print Mode] setting to [Special Settings 1] from the print driver.  e-Manual → Maintenance → Special Mode * When [Special Settings 1] is selected, printing density is lower than when [Off] is selected. Also, text or lines may be less clear.
-----------------	---

Paper Jams Occur Frequently When Performing 2-Sided Printing

Perform the following procedure.

<Cause> Depending on the paper type (especially for thin paper or curled paper), paper jams occur frequently when performing 2-sided printing.

Solution	Change the <Special Mode I> settings from the operation panel.  e-Manual → Maintenance → Special Mode * Maintain this setting <Off> in normal conditions. Change the setting only when the problems mentioned above occur. * If you use this mode when you are not using thin paper, images may become white.
-----------------	---

Registering/Setting the Various Functions

You can set or change machine functions from the setting menu according to your purpose.

Setting Menu List	8-2
--------------------------	------------

Printing a User Data List.....	8-2
Contents of the Setting Menu.....	8-2



Setting Menu List

Printing a User Data List

To see the contents of current settings, print out user's data list.

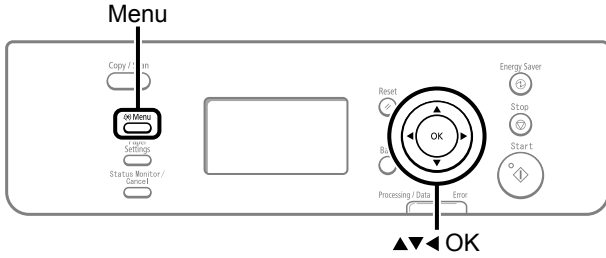
Keys to be used for this operation



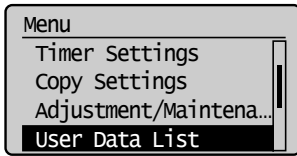

- 1 Press [] (Menu).
- 2 Press [] or [] to select <User Data List>, and then press [OK].

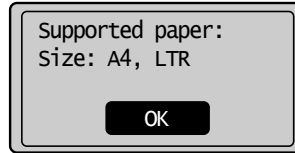

- 3 Ensure that the paper is loaded, and then press [OK].

Load the paper indicated in the display.



- 4 Press [] to select <Yes>, and then press [OK].

Printing starts.

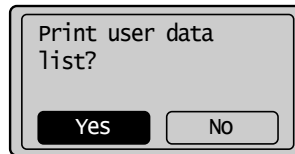

- 5 Press [] (Report) to close <Print Report Lists> screen.



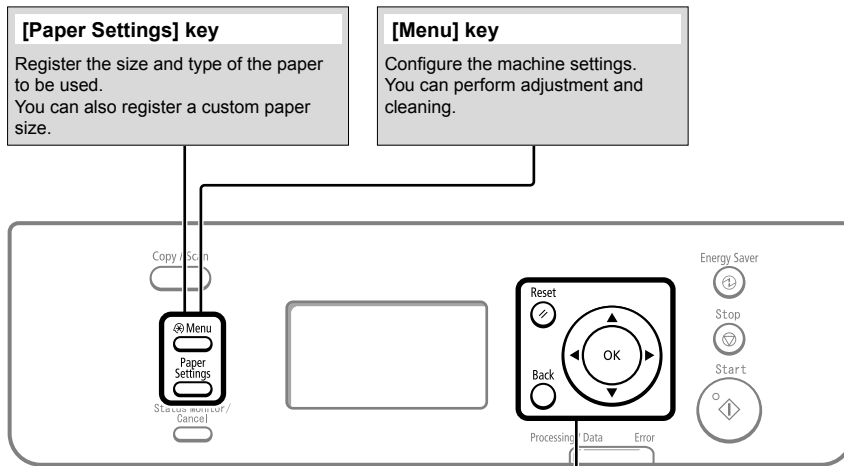

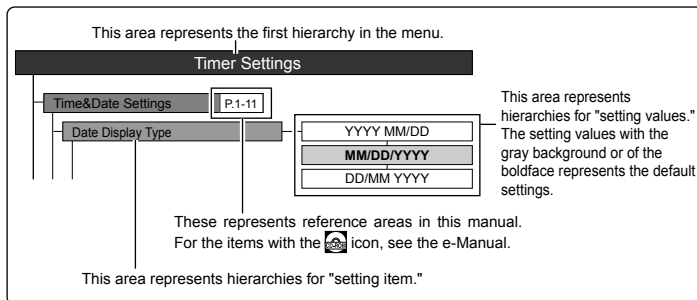

Contents of the Setting Menu



Viewing the Route Map



Menu Operations

	Returns to the previous hierarchy.
	Proceeds to the next hierarchy.
	Selects an upper item/setting value.
	Selects a lower item/setting value.
	Proceeds to the next hierarchy. Also, a setting value is determined, and an operation is performed. * When <Apply> appears in the screen, you need to select <Apply> and press [OK] after specifying the setting.
	Returns to the previous hierarchy.
	Cancels the setting and returns to the initial screen.

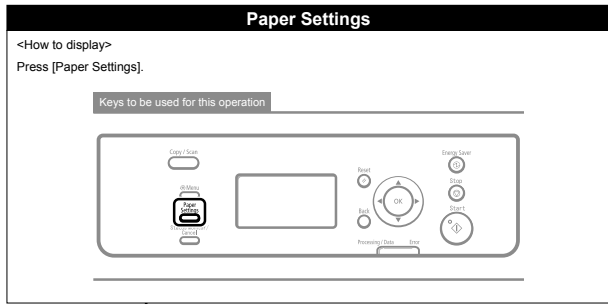

▶ "Setting a Paper Size and Type" (P. 2-16)

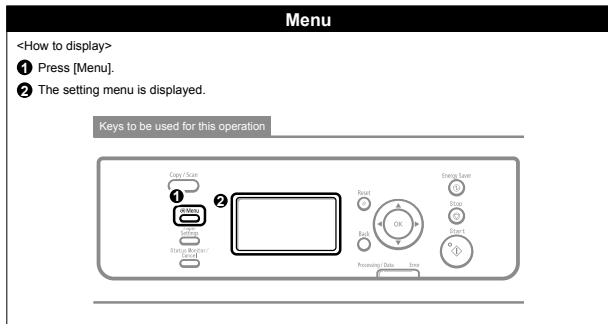

Preferences

Display Settings	
Select Default Screen	Copy Scan Status Monitor/Cancel
Status Monitor/Cancel Device Priority	Off On
Language	English French Portuguese Spanish
Contrast	-2 to 0 to +2
Invert Screen Colors	Off On
mm/Inch Entry Switch	mm Inch
Gram/Pound Switch	Gram Pound
Message Display Time	1 to 2 to 5 (seconds)
Scrolling Speed	Slow Normal Fast
Toner Saver Mode P.6-7	
Copy	Off On
Paper Feed Method Switch	
Multi-Purpose Tray	Print Speed Priority Print Side Priority
Drawer 1	Print Speed Priority Print Side Priority

Continues to the upper right

Continues from the lower left

Timer Settings

Time & Date Settings P.1-11	
Date Display Type	MM/DD/YYYY DD/MM YYYY YYYY MM/DD
12/24 Hour Clock	12 Hour (AM/PM) 24 Hour
Current Time Settings	
Daylight Savings	Off On - Start (M/W/D) - End (M/W/D)
Sleep Timer P.1-10	10 to 240 (minutes)
Auto Reset Timer	0=Off 1 to 2 to 9 (minutes)
Screen After Auto Reset	Default Screen Selected Screen
Auto Offline Time	0=Off 1 to 5 to 60 (minutes)

Copy Settings

Change Defaults P.3-9	
Correct Density	-4 to 0 to +4

Adjustment/Maintenance

Special Processing	
Special Mode U	Off On
Special Mode V	Off Mode 1 Mode 2 Mode 3
Special Mode Z	Off Mode 1 Mode 2 Mode 3 Mode 4
Special Mode B	Off Mode 1 Mode 2 Mode 3
Special Mode C	Off On
Special Mode D	Off On
Copy	Off On
Print	Off On
Special Mode I	Off On
Special Mode J	Off On
Special Mode K	Off On
Clean Fixing Unit P.6-3	

Continues to the next page

Continues from the previous page

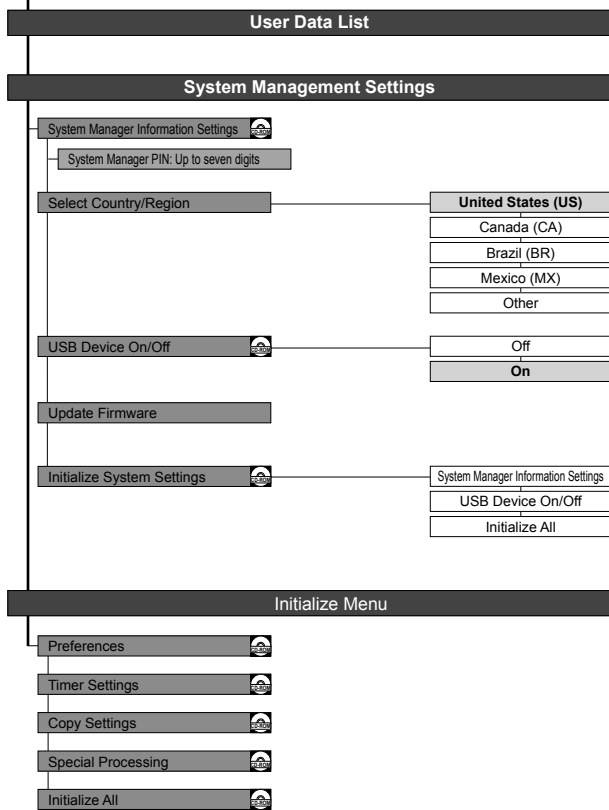

Appendix

This section describes the specifications of the machine and information for Macintosh users.

Main Specifications	9-2
Machine Specifications	9-2
Copy Specifications	9-2
Printer Specification	9-2
Scanner Specifications	9-3
For Macintosh Users	9-4
Displaying Driver Guides (PDF Files)	9-4
Displaying a Driver's Help System	9-4
Content of the e-Manual about Features that Are Unavailable on the Macintosh	9-4
Index	9-5

Main Specifications

Machine Specifications

Machine Specifications	
Type	Personal Desktop
Power Supply	120 to 127 V, 60 Hz (Power requirements differ depending on the country in which you purchased the product.)
Power Consumption	<ul style="list-style-type: none"> Maximum: 1,090 W or less Average consumption during standby mode: Approx. 10 W Average consumption during sleep mode: Approx. 3 W
Warm-up Time	<ul style="list-style-type: none"> 10 seconds or less* (Temperature: 68 °F (20 °C), humidity: 65% RH ; from when the machine is turned on with the power switch to when the standby display appears) * Warm-up time may vary depending on the condition and environment around the machine.
Weight	Main unit (including toner cartridge): Approx. 28.7 lb (13.0 kg)
Dimensions (W x L x H)	15 3/8" x 16 7/8" x 14 1/4" (390 mm x 429 mm x 361 mm)
Installation Space (W x L x H)	24 7/8" x 31 5/8" x 30" (631 mm x 804 mm x 763 mm)
Environmental Conditions	Temperature: 50 to 86°F (10 to 30°C) Humidity: 20% to 80% RH (no condensation)
Acceptable Documents	"Document Requirements" (→P.2-2)
Acceptable Paper Stock	"Paper Requirements" (→P.2-6)
Printable Range	"Printable Range" (→P.2-8)
Scanning Range	"Scanning Range" (→P.2-3)

Copy Specifications

Copy Specifications	
Scanning Resolution	<ul style="list-style-type: none"> Text/Photo (High Speed): 300 dpi x 300 dpi Text/Photo, Photo, Text: 600 dpi x 600 dpi
Output Resolution	600 dpi x 600 dpi
Copy Ratio	<ul style="list-style-type: none"> Direct 1:1 ± 1.0 % Enlargement 1:4.00, 1:2.00, 1:1.29 Reduction 1:0.78, 1:0.64, 1:0.50, 1:0.25 Zoom 0.25 to 4.00, 1% increments
Copy Speed (Letter Plain Direct)*	26 cpm
Successive Copying Capacity	Maximum 99 copies
First Copy Time (Letter)	<ul style="list-style-type: none"> Platen glass: 8.7 seconds or less Feeder: 14 seconds or less

* Speed when using Letter size Plain paper and copying the same data continuously. Depending on the type, size, or feeding direction of the paper, such as when using small size paper, copy speed may become slower. Also, operation may pause or become slow to readjust the temperature or print quality of the machine, when copying continuously.

Printer Specification

Printer Specification	
Printing Method	Indirect electrostatic system (On-demand fixing)
Paper Capacity	Multi-purpose tray: 1 sheet (16 to 21 lb Bond (60 to 80 g/m ²)) Paper cassette: Approx. 250 sheets (16 to 21 lb Bond (60 to 80 g/m ²))
Output Tray Capacity (Letter size paper which has been just opened)	Approx. 100 sheets (16 to 21 lb Bond (60 to 80 g/m ²))* ¹
Print Speed (Letter Plain Direct)* ²	26 ppm
Output Resolution	600 dpi x 600 dpi
Gradation	256 gradations
Toner Cartridge	"Replacing Toner Cartridges" (→P.6-6)

*¹ Actual paper capacity varies depending on the installation environment and paper type to be used.

*² Speed when using Letter size Plain paper and printing the same data continuously. Depending on the type, size, or feeding direction of the paper, such as when using small size paper, print speed may become slower. Also, operation may pause or become slow to readjust the temperature or print quality of the machine, when printing continuously.

Scanner Specifications

Scanner Specifications	
Type	Color scanner
Maximum Scanning Size	<ul style="list-style-type: none"> Platen glass: 8 1/2" x 11 5/8" (215.9 mm x 297 mm) Feeder: 8 1/2" x 14" (215.9 mm x 355.6 mm)
Scanning Resolution	<ul style="list-style-type: none"> Optical resolution Platen glass: 600 x 600 dpi Feeder: 300 x 300 dpi Software interpolation resolution 9600 dpi x 9600 dpi
Scanning Speed (Letter, 300 x 300 dpi)*	<ul style="list-style-type: none"> Platen glass Grayscale: 3 seconds/sheet Color: 15 seconds/sheet Feeder Grayscale: 3 seconds/sheet Color: 13 seconds/sheet
Host Interface	<ul style="list-style-type: none"> 100 Base-TX (Windows only) 10 Base-T (Windows only) Hi-Speed USB USB
Operating System	<ul style="list-style-type: none"> Windows 2000/XP/Vista/7 Mac OS 10.4.9 or later (excluding Classic environment)
Driver	<ul style="list-style-type: none"> TWAIN WIA 1.0 (Windows XP/Vista/7) WIA 2.0 (Windows Vista/7) ICA (Mac OS X 10.6.x)

* The communication time is not included.

● For Macintosh Users

In this manual, methods to operate in the Windows environment are explained as examples. To view how to use printer drivers or utilities for Macintosh, see the following driver guides (PDF files) or driver help systems.

Function	Object	Reference
Print function	Installing the Printer Driver	<ul style="list-style-type: none"> • Starter Guide • Printer Driver Guide
	Printing	<ul style="list-style-type: none"> • Printer Driver Guide
	Using each feature	<ul style="list-style-type: none"> • Printer Driver's Help
Scan function	Installing the Scanner Driver	<ul style="list-style-type: none"> • Starter Guide • Scanner Driver Guide
	Scanning (Setting the MF Toolbox or ScanGear MF)	<ul style="list-style-type: none"> • Scanner Driver Guide

Displaying Driver Guides (PDF Files)

Double-click the following PDF files from the [Manuals] folder on the provided CD-ROM.

- **Printer Driver Guide**
→ [GUIDE-UFR II-US.pdf]
- **Scanner Driver Guide**
→ [GUIDE-SCAN-US.pdf]

Displaying a Driver's Help System

You can use drivers' help systems after you install each driver.

- **Printer Driver's Help**
From the below panels in the [Print] dialog, click [?].
 - [Basic] panel
 - [Advanced] panel

Content of the e-Manual about Features that Are Unavailable on the Macintosh

Among the features explained in the e-Manual, the followings are unavailable on the Macintosh.

- **Installing or uninstalling the e-Manual**

Reference in the e- Manual	"Installing the e-Manual" "Uninstalling the e-Manual"
----------------------------	--

- **Accessory software**

- Presto! PageManager

Reference in the e- Manual	"User Software CD-ROM"
----------------------------	------------------------

- **Some print features**

<Examples>

- Operating in the print server environment
- Watermark printing
- PageComposer (Combining and printing multiple files)
- Changing the halftone
- Adjusting the gamma value

For information on the features that are available on the Macintosh, see the Printer Driver's help system.

Reference in the e- Manual	"Print"
----------------------------	---------

- **Some scan features**

<Example>

- Creating a "Searchable PDF"

For information on the features that are available on the Macintosh, see the Scanner Driver Guide.

Reference in the e- Manual	"Scan"
----------------------------	--------

Index

C

Changing the Default Values	
Copy.....	3-9
Cleaning the Machine.....	6-2
Exterior	6-2
Fixing Unit	6-3
Platen Glass.....	6-4
Contents of the Setting Menu	8-2
Copying.....	3-1
2-Sided Copying.....	3-5
Collating Copies	3-7
Enlarging/Reducing Copies	3-6
ID Card.....	3-8
N on 1.....	3-6
Copy Mode	1-6
Copyright	xii

D

Date Settings.....	1-11
Density	
Copy.....	3-4
Disclaimers.....	xiii
Display	1-6
Display Messages.....	7-7
LCD (Standby Mode)	1-6
Document feeder tray	1-2
Document guides.....	1-2
Documents	
Clearing Jams	7-2
Placing	2-4
Requirements.....	2-2
Scanning Range	2-3
Documents Requirements	2-2

E

Error Code	7-7
------------------	-----

F

Feeder.....	1-2
-------------	-----

H

Handling	vii
----------------	-----

I

If a Power Failure Occurs.....	7-11
If <Incorrect size/setting> Appears	7-8
If You Cannot Solve a Problem.....	7-12
Image Quality	
Copy.....	3-4
Installation	vi
Requirements.....	x
Space.....	x

M

Main Specifications.....	9-2
Copy specifications.....	9-2
Machine Specifications	9-2
Printer Specification	9-2
Scanner Specifications	9-3
Maintenance and Inspections	viii, xi
Multi-purpose Tray	
Paper guide	1-4

O

Operation Panel.....	1-2, 1-5
Output tray.....	1-2

P

Paper

Clearing Jams.....	7-2
Loading.....	2-9
Paper Size and Type.....	2-14
Printable Range.....	2-8
Requirements.....	2-6
Paper Cassette.....	1-2, 1-4
Paper Requirements.....	2-6
Platen glass.....	1-2
Power Supply.....	vi
Requirements.....	x
Printable Range.....	2-8
Printing a User Data List.....	8-2
Printing from a Computer.....	4-1

R

Rear cover.....	1-3
Registering/Setting the Various Functions..	8-1

S

Scan Functions.....	5-1
Scan Mode.....	1-6
Scanning area.....	1-2
Scanning Range.....	2-3
Selecting Print Side.....	2-16
Sharpness	
Copy.....	3-7
Sleep Timer.....	1-10

T

Text Input Method.....	1-9
Time Settings.....	1-11
Toner Cartridge.....	6-6
Handling.....	6-6
Replacing Toner Cartridge.....	6-9
Trademarks.....	xii
Transporting the Machine.....	6-16
Tray extension.....	1-2
Troubleshooting.....	7-1
Clearing Jams.....	7-2
Error Code.....	7-7
If a Power Failure Occurs.....	7-11
If <Incorrect Size/Setting> Appears.....	7-8
If You Cannot Solve a Problem.....	7-12

U

USB port.....	1-3
---------------	-----



CANON INC.

30-2, Shimomaruko 3-chome, Ohta-ku, Tokyo 146-8501, Japan

CANON MARKETING JAPAN INC.

16-6, Konan 2-chome, Minato-ku, Tokyo 108-8011, Japan

CANON U.S.A., INC.

One Canon Plaza, Lake Success, NY 11042, U.S.A.

CANON EUROPA N.V.

Bovenkerkerweg, 59-61, 1185 XB Amstelveen, The Netherlands

CANON CHINA CO. LTD.

15F Jinbao Building No.89, Jinbao Street, Dongcheng District, Beijing 100005, PRC

CANON SINGAPORE PTE LTD

1 HarbourFront Avenue, #04-01 Keppel Bay Tower, Singapore 098632

CANON AUSTRALIA PTY LTD

1 Thomas Holt Drive, North Ryde, Sydney NSW 2113, Australia

CANON GLOBAL WORLDWIDE SITES

<http://www.canon.com/>

